

# POWER 12 Common Pictures

---

## Our Beliefs, Vision and Strategy

### Beliefs

At Endeavor Elementary, we believe in prioritizing significant time during the first weeks of school to create strong school culture. If we take the time to teach, practice and hold students accountable to school-wide expectations, we can create a school culture conducive to rigorous academic learning and strong community. There are daily routines and procedures that have a significant impact on the efficiency and effectiveness of our classrooms. By thinking about them ahead of time and planning for the materials they may require, we will be able to concentrate fully on instruction and classroom management. We do not want to waver or have to expend any mental energy making decisions about these procedures when we are in front of students. Just like any other type of learning, these routines and procedures will need to be practiced by our students. Typically, students become comfortable with them quickly, but there will be times throughout the school year when we will need to articulate and practice them again. As a school staff, we are committed to ensuring school-wide expectations, routines and procedures become deeply engrained scholar habits; we will leverage this strong school culture foundation to ensure academic achievement across our school.

Strong school culture is fundamental to ensuring Endeavor continues breakthrough results even at scale. While school culture can be strengthened, maintained and tweaked throughout the year, its success is largely dependent on what happens during summer staff training and the first month of school; these two crucial moments must be structured so that everyone in a school community—adults and children—get multiple “at bats” with which to create an aligned and consistent school-wide culture.

One of the biggest reasons we’re all here and why we committed to Endeavor is because we believe in a common goal and common approach, and commit to working **together** to meet our ambitious goals. We understand that strong school culture and high instructional expectations will yield the results we strive for, and will deliver on the promise of getting kids to and through college. We need to hit all of our academic and character goals as a means of preparing our kids for college. **But we are not there yet.**

*What is the Common Picture?* The Common Picture is a shared, unified way to teach and train scholars on every school-wide procedure (like walking down the hall and lunch) and classroom-wide procedure (like arrival and packing up), so that classrooms look and feel urgent in the same way (highly consistent), and are very predictable for scholars and teachers. Because we are schoolteachers at Endeavor and teach more than just the 30 scholars in our classrooms, it is important that we have this level of consistency across classrooms. As a result, we can focus close to 100% of our time and energy on management and instruction.

It is the *Common Picture* because we’re all doing it together. *Why?* By spending minimal time on daily routines and procedures because they’ve become deeply ingrained scholar habits, we’re spending close to 100% of voice, creativity, personality, and thinking on rigorous, creative, engaging and joyful lesson execution to ultimately ensure academic achievement across our school. YES!

Thank you for your continued support, positive mindsets, and active participation in and around the Common Picture!

## Contents

<b>Our Beliefs Vision and Strategy</b> .....	1
<b>The Six Week Culture Vision</b> .....	4
<b>2015-2016 Bellwether Dates</b> .....	7
<b>The High Leverage 5</b>	
Posture Habits: SLANT, HALLS, Tracking .....	8
Scholar Academic Habits: Loud & Proud, Vertical Hands, Complete Sentences .....	17
<b>Morning Procedures</b>	
Morning Arrival - Attendance and Uniform Check .....	21
Breakfast .....	23
Bright Work.....	25
Independent Washroom Trips: K/1.....	26
Independent Washroom Trips: 2-4.....	27
<b>Lunch</b>	
Lunch Arrival .....	29
Lunch Table Expectations.....	34
Lunch Clean-Up.....	37
Lunch Dismissal.....	39
<b>Moving Between Space</b>	
Transition from Desks to Rug .....	44
Transition from Rug to Desks .....	51
Lining Up from Desk to Door .....	56
Hallway Transitions .....	61
2-4 Independent Class Transitions.....	64
Stairwell Transitions.....	67
Entrance from Hall to Desks or to Rug .....	70

**Classroom Culture**

Hand Signals and Emergencies..... 72  
Time-Out..... 74

**Social Opportunities**

REACHess ..... 80

**End of Day Procedures**

Pack Up ..... 84  
Cooperative Play.....85  
Van and Bus Dismissal..... 87

## The 6 Week Vision

By Week 6 of a school year, we can tell a lot about the cultural health of a school. How classrooms look, sound and feel is typically a clear indicator of the tone and feel for the remainder of the year. For this reason, we are rallying around a Week 6 Vision of Excellence for establishing foundational school culture upon which we can build. There are a set of key mindsets guiding our Week 6 Strategy:

- **Warm/Demanding:** We will create a school culture where all students are held to unapologetically bold expectations AND feel deeply cared about by all staff.
- **Muscle Memory:** Kids and adults thrive on practice during the first weeks of school in order to transform foundational skills into habits. Habits are non-thinking responses that free up our mental capacity to do the heavy lifting that teaching and learning demand.
- **On Task:** Kids are working hard, at all times and possess strong academic habits. Every minute of learning is leveraged through tight Common Picture routines.
- **Teachers are the deans of their classrooms:** Teachers possess the key skills necessary to manage, influence, and engage every child in their classroom.

This all happens in tandem with rigorous academic instruction. By establishing a warm/demanding environment where teachers hold students to unapologetically high expectations while simultaneously conveying love and support, we set the tone for what joyful rigor will look like across the year. When all of these things work in concert, a foundation is set that leads to unprecedented levels of joy, engagement and learning.

The tables below are guided by backwards planning. First, we outline the Week 6 culture goal so that we know exactly what we are working toward. We then outline the Week 3 midpoint goal so that we will know if we are on track to meeting our ultimate goal. We then outline the teacher strategy we will use during the first two weeks of school to ensure routines and procedures become habit. **It is important to note that while our teacher scaffolding and support will gradually release over time, our expectations for scholar behavior will be consistent from Day 1.**

To execute on this vision, we will teach through the following Taxonomy techniques:

- Strong Voice
- Precise Directions
- Narration
- Positive Framing
- Do It Again
- 100%
- Circulate
- Work the Clock
- Warm-Demanding

## The Week 6 Goal

Routines and Procedures are...	Teacher Support and Narration
<ul style="list-style-type: none"> <li>• <b>Silent:</b> Scholar voices are off.</li> <li>• <b>Safe:</b> Scholars maintain the appropriate amount of space between themselves and others. There is no bumping, pushing or shoving.</li> <li>• <b>Urgent:</b> Individual routines/procedures are completed in 45 seconds or less because scholars respond immediately to teacher cues and move between spaces with purpose.</li> <li>• <b>Efficient:</b> Verbal and non-verbal teacher cuing is swift. Pathways are consistently utilized.</li> <li>• <b>Executed Solely Through Cuing:</b> Teachers facilitate 100% of the time via verbal/nonverbal cues. There is no additional teacher talk.</li> <li>• <b>Executed with Noninvasive Teacher Intervention:</b> Scholars do each procedure independently 95-100% of the time. Teachers rarely intervene. When they do, it is done silently and/or anonymously to maintain the flow of the transition. <ul style="list-style-type: none"> <li>○ <b>Examples include:</b> nonverbal redirects, corrections on the REACH bar communicated in a whisper voice to a scholar, an anonymous correction (Ex: "waiting on one."). <u>There is no narration.</u></li> </ul> </li> <li>• <b>Maintained through Student Problem-Solving:</b> If a rare challenge presents itself, students actively problem solve in ways that maintain the flow of the routine/procedure. <ul style="list-style-type: none"> <li>○ <b>Example:</b> Two classes are passing each other in a narrow hallway. A scholar midway through the line determines she should stop to allow the other class to pass in order to avoid bumping into each other.</li> </ul> </li> </ul>	<ul style="list-style-type: none"> <li>• <b>Cuing:</b> Consistent verbal and nonverbal cues are given.</li> <li>• <b>Do It Better:</b> Scholars rarely require Do It Better because 100% compliance has been achieved in almost every circumstance.</li> <li>• <b>Narration</b> is not necessary.</li> <li>• <b>Positive framing</b> is used sparingly. Rely on challenge and assume the best.</li> <li>• <b>Scanning and Circulating:</b> Teachers consistently scan and circulate as scholars move to check for adherence to directions and 100% compliance with expectations.</li> </ul>

## The Week 3 Goal

Routines and Procedures are...	Teacher Support and Narration
<ul style="list-style-type: none"> <li>• <b>Silent:</b> Scholar voices are off.</li> <li>• <b>Safe:</b> Scholars maintain the appropriate amount of space between themselves and others. There is no bumping, pushing or shoving.</li> <li>• <b>Urgent:</b> Individual routines/procedures are completed in 45 seconds or less because scholars respond immediately to teacher cues and move between spaces with purpose.</li> <li>• <b>Efficient:</b> Verbal and non-verbal teacher cuing is swift. Pathways are consistently utilized.</li> <li>• <b>Executed with Minimal Teacher Facilitation:</b> Teachers facilitate 85-100% of the time via verbal/nonverbal cues. There is no additional teacher talk unless explanation of a given procedural step is absolutely necessary</li> <li>• <b>Executed with Minimal Teacher Intervention:</b> Scholars do each procedure independently 85-100% of the time. Teachers intervene to implement occasional “do it betters” or to narrate the very few actions that may not yet be habit because they are tricky. When teachers intervene to correct individual behaviors, it is done silently and/or anonymously to maintain the flow of the transition.</li> </ul>	<ul style="list-style-type: none"> <li>• <b>Cuing:</b> Consistent verbal and nonverbal cues are given. They are only accompanied by additional what to do directions when necessary.</li> <li>• <b>Narration:</b> Narration only occurs to support particularly challenging components of routines.</li> <li>• <b>Do It Better:</b> Scholars are only asked to Do It Better in order to achieve the highest bar for expectations.</li> <li>• <b>Positive Framing:</b> Scholars should be challenged in more rigorous ways than in earlier weeks so that the routine continues to strengthen.</li> <li>• <b>Scanning and Circulating:</b> Teachers consistently scan and circulate as scholars move to check for adherence to directions and 100% compliance with expectations.</li> </ul> <p><b>Example Teacher Support During a Routine:</b></p> <ul style="list-style-type: none"> <li>• Stand, one. (cuing)</li> <li>• Nick is in the center of his square. (narration)</li> <li>• Turn, two. (cuing)</li> <li>• Transition, three. (cuing)</li> <li>• Alex walking safely and silently (narration)</li> </ul>

## The Week 2 Goal

In order to ensure silence, safety, urgency, efficiency, and execution with minimal teacher facilitation/intervention, teachers do the following during the first two weeks:

- **Explicit Modeling:** All routines/procedures/expectations lessons follow an I-We-You format. All steps are outlined in the lesson.
- **Cuing:** Consistent verbal cues are always given. They are accompanied by consistent nonverbal cues and what to do directions.
- **Narration:** The moment scholars are released to practice a step, teacher narration begins. The teacher continuously narrates until the step is complete.
- **Do It Again:** The teacher actively scans while scholars practice to determine which component(s) require a Do It Again. Repeated “do it agains” are expected in order to increase muscle memory. The teacher will use “break it down” to isolate the various components of a routine that need practice. The teacher will tell scholars how to do it better before letting scholars do it again.
- **Positive Framing:** Scholars are challenged frequently to “do it better” or to “do it like X grade”. Individual scholars are praised for meeting expectations with urgency, enthusiasm and grit.
- **Scanning and Circulating:** Teachers consistently scan and circulate as scholars practice to check for adherence to directions and 100% compliance with expectations. Continuously scanning and circulating ensures the teacher’s presence is felt throughout the room.

Example Teacher Support During a Routine:

- Stand, one. (cuing)
- You are standing up in the center of your square. You are silent. (what to do)
- Tikyra is so silent. King’s lips are zipped. I see Caleb standing up in the center of his square. Ceasar is super still. (narration)
- We’re going to do it again. This time, I want to see everyone stand up at the same time when I say 1. (do it again)
- Let’s see which row can do it the quickest! (positive framing)

### Bellwether Dates:

8/19-9/4: Teacher directed with narration, mechanical student actions.

- K-1<sup>st</sup>: 3 minutes
- 2<sup>nd</sup>-4<sup>th</sup>: 2 minutes

9/7-9/18: Reduced teacher direction and narration. Non-verbals for the number cues, automatic student actions.

- K-1<sup>st</sup>: 1.5 minutes
- 2<sup>nd</sup>-4<sup>th</sup>: 1 minute

9/21-10/2: Zero teacher direction and narration. All non-verbals, internalized scholar actions.

- K-1<sup>st</sup>: 30 seconds
- 2<sup>nd</sup>-4<sup>th</sup>: 30 seconds

# School-Wide Routine: Posture Habits – SLANT, HALLS, and Tracking

Ownership, Accountability and Preparedness	
<b>Overseen by:</b> Principal and deans <b>Owner(s):</b> All Teachers and School Staff	<b>Materials:</b> Visual Anchors
<b>Non-Negotiable:</b> <ul style="list-style-type: none"><li>All grades and all scholars will follow complete CP for Posture Habits. This insures consistency across grades and classrooms and keeps time on task through habitual actions.</li></ul>	

## SLANT:

**Sit Up.** Sitting up with hands folded, fingers interlocked, Elbows bent with forearms on desk to show that everyone is alert and engaged. Sitting up, tummy tucked, chairs pushed in as comfortable as possible. Scholar's legs must sit between the legs of the desk and chair. Still feet. No swinging legs.

**Listen.** Students listen to each other and to their teacher. Therefore, their conversations become more layered and sophisticated. They can build on what was said before, instead of just relying on the basic understanding provided by notes and books.

**Ask and Answer Questions.** Students ask questions, for the teacher's benefit as much as theirs. Encouraging students to ask and answer questions is a way to get them in the habit of demonstrating their understanding themselves, rather than the teacher having to draw it out of them.

**Nod.** This one is really more about Non-Verbal Communication. It's the visual equivalent of asking and answering questions—we're helping students give their teachers cues about whether or not they get what's going on.

**Track the Speaker.** Students are looking at the person speaking so they have an easier time hearing what they're saying and processing that information.





## SLANT PROCEDURE

	Teacher	Scholar
Weeks 0-1	<ul style="list-style-type: none"> <li>• “Scholars show me SLANT”</li> <li>• Teacher quickly scans room no more than 2-4 seconds for compliance</li> <li>• Teacher narrate: “Kevin’s back is tall, Ashley’s tummies tucked, Jen’s hands are locked, Chris’ elbows are on the table, Drew’s legs are still”</li> <li>• Each of the above should be paired with a nonverbal redirection</li> </ul>	See visual on next page
Weeks 1+	<ul style="list-style-type: none"> <li>• Teacher reinforces SLANT with narration paired with non-verbals, (showing scholar SLANT, closed fist forward)</li> <li>• “Row 4 is in SLANT with backs tall” (with a wink) “Niko’s hands are folded on his desk, elbows locked on the table.”</li> <li>• <b>Corrections for SLANT:</b> After directions are given, if you remind a scholar to correct their posture, <u>it is one clip move.</u></li> <li>• <b>If 3 or more scholars are not meeting vision: Teacher Move.</b> Use the Do It Better taxonomy technique:               <ol style="list-style-type: none"> <li>i. Explicitly telling scholars <b>what to fix and do better</b></li> <li>ii. Introducing Do it again with a <b>challenge</b></li> <li>iii. <b>Economizing on language</b> during the Do it again</li> </ol> </li> </ul>	See visual on next page



**These scholars show exemplar SLANT: Hands folded, elbows on table, backs tall, tummy tucked, feet flat, legs together with legs between desk legs.**



**These scholars in SLANT are non-examples: Elbows not locked, hands not folded, feet not forward, legs not together, backs not tall, tummies not tucked.**

## HALLS:

**Hands At Sides.** Hands must not be in pockets, to ensure scholars stay safe if they fall. By having this observable behavior, we can ensure that all scholars are safe in the hallways and protecting our walls, etc.

**All Eyes Forward.** Scholar's eyes are focused in the direction they are going to track their teacher for further instruction.

**Lips Zipped.** Hallways are silent! If scholars have an emergency, they must show the emergency sign (Page 72) instead of using their voices.

**Legs Walking Safely.** Scholars are walking through halls with the line between their legs

**Stick Together.** Scholars move at a safe pace directly after the person in front of them.

### HALLS PROCEDURE:

	Teacher	Scholar
<b>Weeks 0-1</b>	<ul style="list-style-type: none"> <li>• Teacher gives direction for "HALLS", using Call and Response technique</li> <li>• "Scholars when in the hallway our Hands are at our <b>SIDES</b>"</li> <li>• "All eyes are <b>FORWARD</b>"</li> <li>• "Lips are <b>ZIPPED</b>"</li> <li>• "Legs walking <b>SAFELY</b>"</li> <li>• "And most important we, <b>STICK TOGETHER</b>"</li> <li>• Teachers quickly scan room no more than 2-4 seconds for compliance before leaving the classroom</li> <li>• Teacher narrate: "Kevin's eyes are forward, Ashley's lips are zipped, Jen's hands are by her sides, Chris' lips are zipped, Drew's eyes are forward"</li> <li>• Each of the above should be paired with a nonverbal redirection</li> </ul>	See visual on next page
<b>Weeks 1+</b>	<ul style="list-style-type: none"> <li>• Teacher gives direction for "HALLS", using Call and Response technique, if necessary.</li> <li>• Teacher reinforces SLANT with positive narration paired with non-verbals, (showing scholar SLANT, closed fist forward) "Row 4 is in SLANT with backs tall" (with a wink) "Niko's hands are folded on his desk, elbows locked on the table."</li> <li>• <b>Corrections for HALLS:</b> After directions are given, if you remind a scholar to fix posture in the classroom or non-verbally in the hallway, it is one clip move.</li> <li>• <b>If 3 or more scholars are not meeting vision: Teacher Move.</b> <ol style="list-style-type: none"> <li>i. Use non-verbal Do It Better signal in hallway and <b>return to class</b> to reset</li> <li>ii. <b>Explicitly tell</b> scholars what to fix and Do It Better</li> <li>iii. When pressed for time, <b>Practice</b> during REACHess or Coop Play</li> </ol> </li> </ul>	See visual on next page





These scholars show exemplar HALLS: Hands by side, eyes forward, lips zipped, line between the legs, and body directly in front of person in front of them.



Though cute, these scholars are non-examples of HALLS: Hands in pockets, eyes down, untied shoe laces, body on wall, body not behind person in front of you, talking.

## Tracking:

**Tracking** means to be looking at the speaker. This shows engagement, respect, and learning.

**Scholars track their learning at all times.** This includes:

- The teacher when they are speaking
- Peers when they are speaking
- The text or work if it is on the Doc Cam
- DI and Storybook during DI
- Text during read-aloud

Teachers **assume the best** of scholar's and always give a clear direction for where eyes each time the tracking position changes.

To get 100% in Tracking, teachers rely on **Be Seen Looking** and **non-verbal reminder** of two fingers toward eyes, after stating "track (insert name or object) and point"

### Tracking Procedure

	Teacher	Scholar
<b>Weeks 0-1</b>	<ul style="list-style-type: none"> <li>• Before giving a direction to track, all scholars should be in SLANT.               <ul style="list-style-type: none"> <li>• Teacher sets Behavioral expectations</li> </ul> </li> <li>• Teacher gives direction for "<b>hands down, SLANT</b>" if hands are raised.</li> <li>• Teacher says while pointing, "<b>Track the board/Sydney/this book/my eyes.</b>"</li> <li>• Teacher puts up stop sign if it is a scholar talking and states with a smile, "<b>Wait, (scholar) let's make sure we have all eyes.</b>"</li> <li>• Teacher quickly scans the room no more than 2-4 seconds for compliance:               <ul style="list-style-type: none"> <li>- Teacher reinforces tracking with positive narration paired with non-verbals, (smiling) "The entire blue row is tracking Saniyah" (with a wink)"Niko's eyes shot right over to Jarell."</li> </ul> </li> </ul>	<ul style="list-style-type: none"> <li>• <b>See visual on next page</b></li> <li>• <b>SLANT while Tracking at desk:</b> When at a desk tracking someone behind you, scholars rest their hands, folded, on the top of the chair, legs still in their desk space, head turned comfortably and safely toward speaker. If speaker is far away, scholar may turn head in the direction of the speaker.</li> <li>• <b>SLANT while Tracking on rug:</b> When at the rug, tracking someone behind you, scholars rest their hands, folded, in their laps, legs still criss crossed, head turned comfortably and safely toward the speaker, body facing forward.</li> </ul>

<p><b>Weeks 1+</b></p>	<ul style="list-style-type: none"> <li>• Before giving a direction to track, all scholars should be in SLANT. <ul style="list-style-type: none"> <li>• Teacher sets Behavioral expectations</li> </ul> </li> <li>• Teacher gives direction for “<b>hands down, SLANT</b>” if hands are raised.</li> <li>• Teacher says while pointing, “<b>Track the board/Sydney/this book/my eyes.</b>”</li> <li>• Teacher puts up stop sign if it is a scholar talking and states with a smile, “<b>Wait, (scholar) let’s make sure we have all eyes.</b>”</li> <li>• Teacher quickly scans the room no more than 2-4 seconds for compliance:</li> <li>• Teacher reinforces tracking with shorter reinforcement peppered with non-verbals, “So quick, tracking _____” “Thank you, _____” “Yes, _____”</li> </ul> <p><b>Corrections for Tracking:</b></p> <p>*If you remind a scholar with two fingers to eyes to in your 2-4 second scan and they fix it, it is not a clip move. [i.e.: “Jarell, eyes” (non-verbal)]. If they do not track after the reminder, it is one clip move.</p> <ul style="list-style-type: none"> <li>• Teacher says to speaking scholar, “<b>We’re ready, (scholar).</b>”</li> <li>• Teacher monitors for sustained tracking while speaking, teaching, or listening.</li> </ul>	<ul style="list-style-type: none"> <li>• <b>See visual on next page</b></li> <li>• <b>SLANT while Tracking at desk:</b> When at a desk tracking someone behind you, scholars rest their hands, folded, on the top of the chair, legs still in their desk space, head turned comfortably and safely toward speaker. If speaker is far away, scholar may turn head in the direction of the speaker.</li> <li>• <b>SLANT while Tracking on rug:</b> When at the rug, tracking someone behind you, scholars rest their hands, folded, in their laps, legs still criss crossed, head turned comfortably and safely toward the speaker, body facing forward.</li> </ul>
------------------------	--	---



**These scholars show exemplar Tracking: Still in SLANT, head facing speaker, eyes on the speaker. When tracking someone behind you, scholars keep as comfortable as possible. Legs stay together, in your space.**



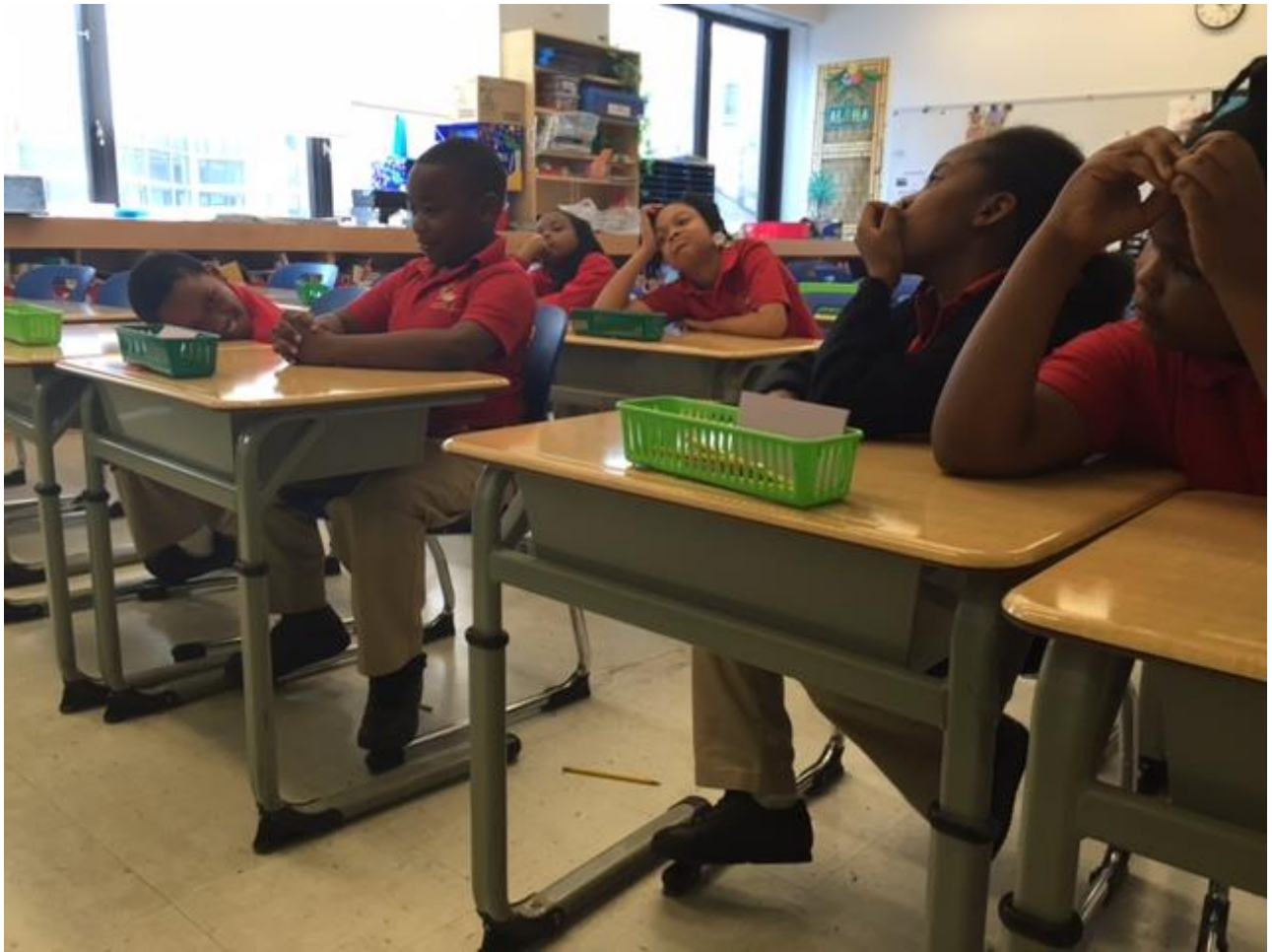

**These scholars are showing non-examples of Tracking: Though facing the speaker, hands on face, hands not folded, hands in hair, hands in mouth, body on neighbor's desk.**



# School wide Routine: Scholar Academic Habits - Loud and Proud, Vertical Hands, Complete Sentences

Ownership, Accountability and Preparedness	
<b>Overseen by:</b> Principal and deans <b>Owner(s):</b> All Teachers  <b>Non-Negotiables:</b> <ul style="list-style-type: none"> <li>All grades and all scholars will follow complete CP for Scholar Academic Habits. This insures consistency across grades and classrooms and keeps time on task through habitual actions.</li> </ul>	<b>Materials:</b> Visual Anchor

## Loud and Proud:

At Endeavor, scholars are expected to answer in a **loud, proud voice**.

- This means that the scholar uses a **volume that the entire class can hear**. This is not a yell.
- Scholars speak in a loud and proud without needing to be prompted.

## LOUD AND PROUD PROCEDURE:

	Teachers	Scholars
<b>Weeks 0-1:</b>	<ul style="list-style-type: none"> <li>Before asking scholars to answer, teachers reinforce with the reminder of "I'm looking for a scholar that is loud and proud" or "Who's ready to show voice to the entire class?"</li> <li>Teacher calls on scholar to answer</li> <li>Teacher scans for Tracking expectations               <ul style="list-style-type: none"> <li>The silent signal for the need to increase volume is finger to ear for both scholars and teachers</li> </ul> </li> </ul>	<b>See CP Video</b>
<b>Weeks 1+:</b>	<ul style="list-style-type: none"> <li>Before asking scholars to answer, teachers reinforce with the reminder of "I'm looking for a scholar that is loud and proud" or "Who's ready to show voice to the entire class?"</li> <li>Teacher calls on scholar to answer</li> <li>Teacher scans for Tracking expectations</li> <li>If a scholar is reminded of loud and proud and does not change their volume, they choose a clip move.</li> </ul>	<b>See CP Video</b>

## Vertical Hands:

**Vertical hands are raised in this way:**

**One arm straight up**, parallel to the ear. Closed fingers. Fingers may move with gusto to show enthusiasm.

**Bottom stays in seat.** When using Vertical Hands, scholars must stay seated in their chair or carpet square.

**Helping hand** folded on the desk or in lap.

### VERTICAL HANDS PROCEDURE:

	Teachers	Scholars
<b>Weeks 0-1:</b>	<ul style="list-style-type: none"> <li>• Teacher asks question and gives direction for <b>"HANDS"</b></li> <li>• Teacher quickly scans room no more than 2-4 seconds for compliance</li> <li>• Teacher narrate: "Kevin's arm is straight up, Ashley's fingers are closed, Jen's showing excitement by wiggling her fingers, Chris' is still glued to the rug/chair, Drew's helping hand is folded on the desk/in his lap"               <ul style="list-style-type: none"> <li>○ Each of the above should be paired with a nonverbal redirection</li> </ul> </li> </ul>	<p><b>See visual on next page.</b></p>
<b>Weeks 1+:</b>	<ul style="list-style-type: none"> <li>• Teacher asks question and gives direction for <b>"HANDS"</b> <ol style="list-style-type: none"> <li>a. Teacher reinforces HANDS with positive narration paired with non-verbals, (showing scholar HANDS, you modeling exemplar) "Row 4 has hands straight up" (with a wink) "Niko's glued to his seat/rug, Tommy's elbows locked on the table."</li> <li>b. <b>Corrections for HANDS:</b> After directions are given, provide non-verbal reminders. We don't want scholars to shy away from answering questions due to clip move. Reaffirm their excitement for learning while also reminding them of exceptional habits.</li> <li>c. <b>If 3 or more scholars are not meeting vision: Teacher Move.</b> Use the Do It Better taxonomy technique:               <ol style="list-style-type: none"> <li>i. Explicitly telling scholars <b>what to fix and do better</b></li> <li>ii. Introducing Do It Better with a <b>challenge</b></li> <li>iii. <b>Economizing on language</b> during the Do It Better</li> </ol> </li> </ol> </li> </ul>	<p><b>See visual on next page.</b></p>



These scholars are showing exemplar Vertical Hands: Helping hand on desk, elbow to ear, hand straight up, fingers together, tummy tucked, and bottom in the chair, feet flat, and legs in your desk space.

|

## Complete Sentences:

Scholars use **Complete Sentences** when answering questions. They restate the question and provide their answer, using a Loud and Proud voice. Why? Complete sentences are the articulate way to communicate thoughts to others and prepares our scholars for life in and out of Endeavor Elementary.

### COMPLETE SENTENCES PROCEDURE:

Weeks	Teachers	Scholars
<b>Weeks 0-1:</b>	<ul style="list-style-type: none"> <li>• Teacher calls on scholar to answer question (“Tommy, in a <b>Complete Sentence</b>, why did the chicken cross the road?”)</li> <li>• Teacher quickly scans room for 100% Tracking from all others</li> <li>• Tommy answers: “To get to the other side”</li> <li>• Teacher states: “Use a <b>Complete Sentence</b>”               <ul style="list-style-type: none"> <li>○ Each of the above should be paired with a nonverbal (Pinch hands together and stretch like stretching a piece of gum)</li> </ul> </li> <li>• Tommy answers: “The chicken crossed the road to get to the other side”</li> </ul>	<b>See CP Video</b>
<b>Weeks 1+:</b>	<ul style="list-style-type: none"> <li>• Teacher calls on scholar to answer question (“Tommy, in a <b>Complete Sentence</b>, why did the chicken cross the road?”)</li> <li>• Teacher quickly scans room for 100% Tracking from all others</li> <li>• Tommy answers: “To get to the other side”</li> <li>• Teacher states: “Use a <b>Complete Sentence</b>”               <ul style="list-style-type: none"> <li>a. Each of the above should be paired with a nonverbal (Pinch hands together and stretch like stretching a piece of gum)</li> </ul> </li> <li>• Tommy answers: “The chicken crossed the road to get to the other side”</li> <li>• If a scholar is reminded of Complete Sentence and does not, they choose a clip move.</li> </ul>	<b>See CP Video</b>

# School-wide Routine: Morning Arrival - Attendance and Uniform Check

Ownership, Accountability and Preparedness	
<p><b>Overseen by: Leadership Team</b>  <b>Owner(s): Co-Teachers</b></p> <p><b>Non-Negotiables:</b></p> <ul style="list-style-type: none"> <li>• <b>Teacher I</b> is seated with back up against the open door, just inside the classroom, facing the door while also scanning the general classroom for management, and greeting scholars with uniform check as they enter.</li> <li>• <b>Teacher I</b> completes attendance and uniform and inputs to IC (attendance)/ Kickboard (uniform).</li> <li>• <b>Teacher II</b> is seated at the U-Table checking homework, facing the general classroom for management.</li> <li>• <b>All technology is away by 7.35 am (except Teacher II inputting Homework data in Kickboard)</b></li> </ul>	<p><b>Materials:</b></p> <ul style="list-style-type: none"> <li>○ Kickboard</li> <li>○ Uniform Tracker</li> <li>○ Laptop for Attendance in IC</li> <li>○ Cell Phone to text families</li> </ul>

## Morning Arrival – Attendance and Uniform Check Procedure

Teacher I	Teacher II	Scholars
<ul style="list-style-type: none"> <li>○ <b>Before 7.15:</b> Teachers have put <u>all chairs down</u>, Morning Motivation PowerPoint prepped, Bright Work ready and out, and ensured classroom is 100% prepared for scholars.</li> <li>○ <b>7.15 – 7.30:</b> Teacher sits in doorway, positioned as detailed above, and has scholars stop for a <b>Uniform Check</b> (head, ears, shirt, belt, logo'd pants, socks, sneakers).</li> <li>○ Teacher marks any <i>out</i> of uniform scholars on Kickboard.</li> <li>○ Once scholar uniform check has been completed, Teacher sends scholar off with a quick positive Threshold greeting (i.e.</li> </ul>	<ul style="list-style-type: none"> <li>○ <b>Before 7.15:</b> Teachers have put <u>all chairs down</u>, Morning Motivation PowerPoint prepped, Bright Work ready and out, and ensured classroom is 100% prepared for scholars.</li> <li>○ <b>7.15-7.45:</b> Teacher is grading homework at the U-Table as students enter the classroom.</li> <li>○ Teacher monitors scholars as they unpack, begin breakfast, and Bright Work.</li> <li>○ <b>7.43:</b> Teacher inputs Homework data into Kickboard</li> </ul>	<ul style="list-style-type: none"> <li>○ Scholars silently stop, in HALLS, at Threshold, to be greeted by teacher.</li> <li>○ Scholar completes Uniform Check and prepares to unpack materials</li> <li>○ After Uniform Check and entering classroom, scholars must take Homework Folder to Teacher II at U-Table before unpacking all other materials.</li> </ul>

<p>“Have a good day”, “Be ready to work honey”, “Hey X, I am so happy to see you!” “No tears, you’re going to have a great day”, etc.).</p> <ul style="list-style-type: none"> <li>○ Teacher is also monitoring scholars as they unpack; begin breakfast, and Bright Work.</li> <li>○ <b>7.30-7.35:</b> Teacher is sending texts or phone calls to families re: Uniform (i.e. “Good Morning. There is a portion of your scholar’s uniform that is incomplete. Complete uniform is _____.” And please remember, no accessories (headbands, watches, etc.) Have a great day! ☺).</li> <li>○ If time permits, send texts or make phone calls to families whose scholars are absent or ill.</li> <li>○ <b>7.35: Submit attendance using IC, all technology away.</b></li> <li>○ Please <u>do not</u> mark scholars tardy in IC if they come late. They are marked in Main Office.</li> </ul>		
--	--	--

## School-wide Routine: Morning Arrival – Breakfast

Ownership, Accountability and Preparedness	
<p><b>Overseen by:</b> Deans and Principal</p> <p><b>Owner(s):</b> Hallway Monitors, Co-Teacher Pairs</p> <p><b>Non-Negotiables:</b></p> <ul style="list-style-type: none"> <li>○ All classrooms must have hooks labeled with a number for each student to place their materials (coat or jacket with hat, scarf, gloves, tucked in the sleeve)</li> <li>○ All cubbies must be labeled with a number for each student to place materials (backpack and school shoes)</li> <li>○ Each hallway monitor should be in his/her assigned position prior to 7:15am.</li> <li>○ Classroom must be fully ready to accept students by 7:10 am (with breakfasts on desks for Kindergarten). Teachers must be in classrooms by 7:10 am in case the doors open early due to inclement weather.</li> <li>○ Breakfast will be silent to ensure a calm start of the academic day.</li> <li>○ Teachers should not be on cell phones, prepping for lessons, or working on computers except for completing attendance and uniform tracking.</li> <li>○ Scholars enter calmly and silently.</li> <li>○ Bright Work Packets are created for the month. Packets are labeled by day with matching symbol to mark each day.</li> <li>○ <b>Scholars may not bring outside breakfast to school.</b></li> <li>○ <b>All technology is away by 7.35 am (except Teacher II inputting Homework data in Kickboard).</b></li> </ul>	<p><b>Materials:</b></p> <ul style="list-style-type: none"> <li>○ breakfast bags</li> <li>○ lunch bins</li> <li>○ paper towels</li> <li>○ Sporks</li> <li>○ large garbage can</li> </ul>

### Morning Arrival – Breakfast Procedure:

Teacher I	Teacher II	Scholars
<ul style="list-style-type: none"> <li>○ <b>Before 7.15:</b> Teachers have put <u>all chairs down</u>, Morning Motivation PowerPoint prepped, Bright Work ready and out, and ensured classroom is 100% prepared for scholars.</li> <li>○ <b>7.15-7.30: Uniform Check.</b></li> <li>○ <b>7.30-7.36:</b> Circulate class for management, relationship build; ensure scholars are ready for the day.</li> </ul>	<ul style="list-style-type: none"> <li>○ <b>Before 7.15:</b> Teachers have put <u>all chairs down</u>, Morning Motivation PowerPoint prepped, Bright Work ready and out, and ensured classroom is 100% prepared for scholars.</li> <li>○ <b>7.15-7.45:</b> Teacher is grading homework at the U-Table as students enter the classroom.</li> <li>○ Teacher monitors scholars as they unpack, begin breakfast, and Bright Work.</li> </ul>	<ul style="list-style-type: none"> <li>○ Scholars enter the Elementary Entrance.</li> <li>○ <b>Elementary Entrance stairs:</b></li> <li>○ <u>2<sup>nd</sup> grade</u> walks up the right side</li> <li>○ <u>3<sup>rd</sup> and 4<sup>th</sup> grade</u> walk up on the left side</li> <li>○ <b>First Floor:</b> <u>Kindergarten</u> walks up the right side; <u>1<sup>st</sup> grade</u> walks up the left side</li> <li>○ Scholars are greeted at the door by Threshold teacher greeting.</li> <li>○ Uniform check (See above).</li> <li>○ In Classroom:</li> <li>○ Scholars immediately</li> </ul>

<ul style="list-style-type: none"> <li>○ <b>7.36:</b> Teacher says, "Bright work and pencils away in 10...3...1". (Scholars silently and quickly put work in pre-labeled folder that is only used for Bright work.).</li> <li>○ For scholars who have yet to clear breakfast, they will now stand and throw all breakfast away(see Scholars column).</li> <li>○ <b>7.38:</b> Teacher will <b>Call to Attention.</b></li> <li>○ Transition from Desk to Rug for Morning Motivation.</li> <li>○ <b>7.40: Morning Motivation begins.</b></li> </ul>	<ul style="list-style-type: none"> <li>○ <b>7.43:</b> Teacher inputs Homework data into Kickboard.</li> </ul>	<p>unpack (turn in HW folder to teacher at the U table; hat, scarf, and gloves in sleeve of coat. Coat on hook. Backpack in cubby.)</p> <ul style="list-style-type: none"> <li>○ <b>Scholars place all materials on the cubby and hook with their labeled number.</b></li> <li>○ Scholars get their breakfast baggie and go to their desk.</li> <li>○ Before eating breakfast, scholar takes out Bright Work packet to complete while they eat.</li> <li>○ Scholars may Cleanup breakfast as they finish.</li> <li>○ Continue to work on Bright work until 7.36.</li> </ul> <ul style="list-style-type: none"> <li>○ <b>School Wide Breakfast Cleanup:</b>  <b>-When they are done or at 7.36,</b> all dry items back inside baggie            -Scholar carefully stands up.            -Scholar picks up milk and baggie and slowly walks to centrally located trash can.</li> </ul> <ul style="list-style-type: none"> <li>○ <b>7.38: All desks should be cleared of breakfast at this point. Scholars in SLANT</b></li> <li>○ <b>7.38:</b> Transition to Rug. Morning Motivation begins.</li> </ul>
<ul style="list-style-type: none"> <li>○ <b><u>Kindergarten Week 1-3:</u></b></li> <li>○ As Kindergarten scholars finish, clean-up is teacher-ran. As scholars finish, teacher walks scholar through closing milk and placing all dry items inside the baggie.</li> <li>○ Then, teacher collects trash.  <b>By Week 3,</b> Kindergarten should follow the <u>School Wide Procedure.</u></li> </ul>		



# School-wide Routine: Bright Work CP

Ownership, Accountability and Preparedness	
<p><b>Overseen by:</b> TIRs and deans</p> <p><b>Owner(s):</b> GLLs, TIRs, deans</p> <p><b>Non-Negotiables:</b></p> <ul style="list-style-type: none"><li>○ Bright Work is on brightly colored, easy to find, paper ☺</li><li>○ Packets are planned for and created monthly by GL TIR</li><li>○ There are three pages per day</li><li>○ <b>Week 0-6:</b> Bright Work is used during arrival and any down time. This provides scholars quick access to work they can complete independently as they internalize Common Pictures</li><li>○ <b>Week 6+:</b> Bright Work must be work scholars can independently complete with success. This ensures we build no bad habits during this time</li><li>○ Bright Work includes: Reading Passage, Math Facts, Word Search, Cross Word Puzzles, etc.</li><li>○ K/1: Bright Work must have a symbol for each day of the week (ex: Stars=Monday, Suns=Tuesday, etc.)</li><li>○ 2,3,4: Bright Work must have the Day of the Week labeled on the top of each page</li></ul>	<p><b>Materials:</b></p> <ul style="list-style-type: none"><li>○ Bright Work Packet for the entire month (25 days planned for)</li></ul>

# School-wide Routine: Independent Washroom Trips: K-1<sup>st</sup> Grade

Ownership, Accountability and Preparedness	
<p><b>Overseen by: Deans and Principal</b>  <b>Owner(s): ALL Staff</b></p> <p><b>Non-Negotiables:</b></p> <ul style="list-style-type: none"> <li>• The cleanliness of Washrooms is imperative through the school day</li> <li>• Teachers <b>MUST</b> do a thorough job of explaining the following:               <ul style="list-style-type: none"> <li>○ There is <b>NO</b> option to go during learning time.</li> <li>○ Scholars may <b>NOT</b> go during mini-lesson or exit ticket</li> <li>○ This is an honor-accountability system. If you prove that you cannot be trusted over time, you will be unable to go to the washroom unsupervised.</li> <li>○ <b>HAND SANITIZER OR SOAP IS TO BE USED ON INDIVIDUAL TRIPS TO THE WASHROOM.</b></li> </ul> </li> <li>• Acceptable washroom times are as follows:               <ul style="list-style-type: none"> <li>○ Snack</li> <li>○ Lunch</li> <li>○ Computer</li> <li>○ REACHess</li> <li>○ IP</li> </ul> </li> <li>• Scholars are <b>NEVER</b> to use the washrooms or water fountains in the lobby.</li> <li>• Washrooms are closed at <u>3.45</u> unless emergency. Then, teacher must escort scholar to ensure proper EOD dismissal.</li> <li>• If a scholar has used the washroom during all acceptable and unacceptable times of day, parents should be contacted to discuss any medical issues that might need to be addressed.</li> <li>• Use teacher judgment for emergency.</li> </ul>	<p><b>Materials:</b></p> <ul style="list-style-type: none"> <li>○ None</li> </ul>

## Independent Washroom Trips: K-1<sup>st</sup> Grade Procedure:

Teacher	Scholar
<ul style="list-style-type: none"> <li>• Teacher will acknowledge scholar and they will go to washroom               <ul style="list-style-type: none"> <li>○ K: Use in class washroom</li> <li>○ 1<sup>st</sup> Grade: Use washroom across from classroom</li> <li>○ Specials: Use Specials class' respective washrooms</li> </ul> </li> </ul>	<ul style="list-style-type: none"> <li>• Scholar will show the aligned washroom sign               <ul style="list-style-type: none"> <li>○ Vertical Hand with 4 fingers up</li> <li>○ Arms crossed in an X when EMERGENCY</li> </ul> </li> </ul>

# School-wide Routine: Independent Washroom Trips: 2<sup>nd</sup> – 4<sup>th</sup> Grade

Ownership, Accountability and Preparedness																			
<p><b>Overseen by: Deans and Principal</b></p> <p><b>Owner(s): ALL Staff</b></p> <p><b>Non-Negotiables:</b></p> <ul style="list-style-type: none"> <li>• The cleanliness of Washrooms is imperative through the school day</li> <li>• Staff <b>MUST</b> do a thorough job of explaining the following:               <ul style="list-style-type: none"> <li>○ Learning time is learning time. Going to the washroom is not an opportunity to play, hang out with friends, or converse.</li> <li>○ This is an honor-accountability system. If you prove that you cannot be trusted over time, you will be unable to go to the washroom unsupervised.</li> <li>○ Teach the Emergency signal as an 'X' made with the arms and upheld at eye level. If pass is there, Child should be given permission to use the washroom at that time. If pass is out, they must be individually escorted to the washroom by a teacher at his/her earliest availability.</li> <li>○ <b>No more than one scholar out of class, per block, at a time.</b></li> </ul> </li> <li>• Each class will have a bathroom tracker of scholars that will travel with them. This roster will note the number of times the same scholar leaves the classroom to the washroom.</li> <li>• Scholars are <b>NEVER</b> to use the washrooms or water fountains in the lobby.</li> <li>• <b>Scholars in the washroom without this pass or an escort will be sent back to class.</b></li> <li>• Optimal washroom times are as follows.               <ul style="list-style-type: none"> <li>○ Snack</li> <li>○ Lunch</li> <li>○ Computer</li> <li>○ REACHess</li> <li>○ IP</li> </ul> </li> <li>• If a scholar has used the washroom during all acceptable and unacceptable times of day, parents should be contacted to discuss any medical issues that might need to be addressed.</li> <li>• <b>In the event we have defacing or destruction of the property in the bathroom we must be able to pinpoint who was in there and the tracker allows us to do this.</b></li> </ul>		<p><b>Materials:</b></p> <ul style="list-style-type: none"> <li>○ Roster to mark washroom visit per block</li> <li>○ Washroom pass on ring</li> </ul> <p>An example is provided here:</p> <table border="1"> <thead> <tr> <th>Scholar</th> <th>1<sup>st</sup> subject/block here</th> <th>2<sup>nd</sup> subject/block here</th> <th>3<sup>rd</sup> subject/block here</th> </tr> </thead> <tbody> <tr> <td>Jaidyn</td> <td>III</td> <td></td> <td>II</td> </tr> <tr> <td>Maya</td> <td></td> <td>I</td> <td></td> </tr> <tr> <td>Nydera</td> <td></td> <td></td> <td>III</td> </tr> </tbody> </table>		Scholar	1 <sup>st</sup> subject/block here	2 <sup>nd</sup> subject/block here	3 <sup>rd</sup> subject/block here	Jaidyn	III		II	Maya		I		Nydera			III
Scholar	1 <sup>st</sup> subject/block here	2 <sup>nd</sup> subject/block here	3 <sup>rd</sup> subject/block here																
Jaidyn	III		II																
Maya		I																	
Nydera			III																

### Independent Washroom Trips 2<sup>nd</sup> – 4<sup>th</sup> Grade Procedure:

Teachers	Scholars
<ul style="list-style-type: none"> <li>• Each class will have a <b>roster</b> of scholars that will travel with them.</li> <li>• Each classroom will have a <b>Laminated Hall Pass</b>. This pass will be on a ring hook, to the Right of the classroom light switch.</li> <li>• <b>Teacher is responsible for observing scholars take pass from class, sign out, and return pass to the hook.</b></li> </ul>	
<ul style="list-style-type: none"> <li>• Teacher acknowledges with a nonverbal nod or thumbs up and reminder to sign out               <ul style="list-style-type: none"> <li>○ Teacher must ensure scholar takes pass, signs out, and returns the pass.</li> </ul> </li> <li>• Teacher ensures no more than one scholar is out of the room at any given time.</li> </ul>	<ul style="list-style-type: none"> <li>• Scholar raises hands to signal they must use the washroom</li> <li>• Scholar signs out from Tracker and takes the pass from by the door.</li> <li>• <b>Scholars must take the pass with them to the washroom.</b></li> <li>• Scholar leaves pass on hook on washroom door, does their business, and returns pass to <b>hook in the classroom.</b></li> </ul>

## School-wide Routine: Lunch Arrival

Ownership, Accountability and Preparedness	
<p><b>Overseen by:</b> Dean Lunch Lead</p> <p><b>Owner(s):</b> Teachers (transition and drop-off), Lunch monitors (during lunch), Expeditors (during lunch)</p> <p><b>Non-Negotiables:</b></p> <ul style="list-style-type: none"> <li>○ The transition to lunch is silent.</li> <li>○ Stairwells have 1 grade level per line <b>for lunch only</b> and hallways are always one line of 30.</li> <li>○ Each grade level uses their respective hand sanitizer dispenser, and then move through their lunch lines.</li> <li>○ One teacher must stay with their class through the transition while scholars move through the lunch line to their seats.               <ul style="list-style-type: none"> <li>○ <b>Weeks 1-6:</b> All hands on deck with a gradual release of control to the lunch monitors. Teachers will remain with class and reinforce and model lunch lead and lunch monitor’s expectations. <b>Teachers must bring allergy list daily to lunch.</b></li> <li>○ <b>Week 6+,</b> If your GRADE has <u>not met</u> the vision, all teachers will remain until all class is seated.</li> <li>○ <b>Week 6+:</b> One teacher will <u>always</u> be on with their class until all scholars are seated.</li> </ul> </li> <li>○ Scholars with their OWN lunch will enter café threshold, walk through line, and walk to table <b>once standing near service line. Scholars must walk up center isle to their table.</b></li> <li>○ Scholars sit 4 to a bench.</li> <li>○ Expeditor must always track names of scholars who eat lunch. <b>This must never be a scholar job.</b></li> <li>○ Corrections and relationships building with scholars will happen during cooperative play and REACHess in the first month of school. This can occur during lunch when scholars have earned talking time.</li> </ul>	<p><b>Materials:</b></p> <ul style="list-style-type: none"> <li>○ REACH Bar</li> <li>○ Scholar lunch chart and name plates to track those eating lunch</li> <li>○ Lunches for those who brought them into school</li> <li>○ Allergies list (posted near each service line)</li> </ul>

### Lunch Arrival Week 1-6 Procedure:

Teachers I & II	Scholars	Lunch Monitors, Expeditors, Lunch Lead
<ul style="list-style-type: none"> <li>○ Line scholars up in the classroom using line order and CP Line UP</li> <li>○ Transition class to the cafeteria at specified time, not earlier or later using the schedule outlined for your grade level.</li> <li>○ Transition down stairs as follows: -K, 1<sup>st</sup>, 3<sup>rd</sup> Grades: Right side of stairs -2<sup>nd</sup>, 4<sup>th</sup> Grades: Left side of stairs</li> <li>○ In the hallways, reinforce silence and HALLS using non-verbals. <b>Teacher I</b> at front of the line, <b>Teacher II</b> at the midway point of the line.</li> <li>○ Monitor scholars as they move through the service line               <ul style="list-style-type: none"> <li>○ After first 5-6 scholars have trays, <b>Teacher I</b> will ensure scholars sit at their appropriate table spot.</li> <li>○ <b>Teacher II</b> continues to monitor the line until all scholars have received lunch.</li> <li>○ <b>Both Teachers</b> use nonverbal only so scholars are habituated to monitors and lead's voice ONLY.</li> </ul> </li> <li>○ Once all scholars are seated, <b>Teacher I</b> and <b>Teacher II</b> circulate silently and ensure scholars are upholding lunch expectations.</li> </ul>	<ul style="list-style-type: none"> <li>○ <u>Scholars Hallways and Stairs to Lunch:</u> Scholars walk in the hallway in one solid line, and once they reach stairs, stay in one line down the stairs.</li> <li>○ Transition down stairs as follows: -K, 1<sup>st</sup>, 3<sup>rd</sup> Grades: Right side of stairs -2<sup>nd</sup>, 4<sup>th</sup> Grades: Left side of stairs</li> <li>○ Transition silently in HALLS, stopping at every stop sign with hand on the rail.</li> <li>○ Get one pump of Hand Sanitizer from dispenser at Cafeteria threshold.</li> <li>○ Say PETSU words when retrieving their tray.</li> <li>○ If own lunch, <u>stay in single class line until at front of service line. Then, scholar walks off the line, up middle isle, to their seat.</u></li> <li>○ Walk up inside aisle to get to their lunch table: -K, 1<sup>st</sup>, 3<sup>rd</sup>: Blue line -2<sup>nd</sup> &amp; 4<sup>th</sup>: Red line</li> <li>○ <b>Week 0-4:</b> Remain silent during lunch.</li> </ul>	<ul style="list-style-type: none"> <li>○ <b>Monitors:</b> Model silence for scholars, and use nonverbal cues to redirect and redirecting with whispers only when necessary.</li> <li>○ <b>Monitors and Expeditors:</b> Absolute silence! Refrain from talking to each other or be on cell phones as their attention should be on monitoring and reinforcing expectations for silence.</li> <li>○ <b>Monitors:</b> If your table has yet to arrive, be proactive! Circulate at tables that have scholars.</li> <li>○ <b>Monitors: Actively move</b> between the two tables, constantly scanning and reinforcing expectations for silence, assisting with opening packages, or encouraging scholars to eat.</li> <li>○ <b>Monitors:</b> Place REACH bar for the class on the column between the class' tables</li> <li>○ <b>Monitors:</b> Dismisses scholars to the restrooms showing the signal.</li> <li>○ <b>Monitors:</b> Remind scholars that washrooms are closed until all scholars are seated</li> <li>○ <b>Expeditor</b> is responsible for placing all items, including milk, on all scholar's trays</li> <li>○ <b>Expeditor:</b> All scholars must get all foods unless their name is displayed on allergy list.</li> <li>○ <b>Expeditor is responsible for tracking scholars not eating school lunch</b> by removing their name tags from class board.</li> <li>○ <b>Lunch Lead:</b> Monitors the first 4 tables while Expeditors are running the service line.</li> <li>○ <b>Lunch Lead:</b> Actively narrates good scholar habits</li> </ul>

### Lunch Arrival Week 6+ Procedure:

Teachers I & II	Scholars	Lunch Monitors, Expeditors, Lunch Lead
<ul style="list-style-type: none"> <li>○ Line scholars up in the classroom using line order and CP Line UP</li> <li>○ Transition class to the cafeteria at specified time, not earlier or later using the schedule outlined for your grade level.</li> <li>○ Transition down stairs as follows: -K, 1<sup>st</sup>, 3<sup>rd</sup> Grades: Right side of stairs -2<sup>nd</sup>, 4<sup>th</sup> Grades: Left side of stairs</li> <li>● In the hallways, reinforce silence and HALLS using non-verbals. <b>Teacher I</b> at front of the line, <b>Teacher II</b> at the midway point of the line.</li> <li>● <b>Both Teachers</b> monitor scholars until they enter the cafeteria threshold <ul style="list-style-type: none"> <li>○ <b>One Teacher</b> stays with class until the first 5-6 scholars arrive to their assigned lunch table.</li> <li>○ The <b>Teacher that does not stay</b> will be responsible to pick up the class from lunch so that both teachers get equitable prep time</li> </ul> </li> <li>● Note: If lunch is not aligned to strong CP, all teachers will return to Phase I.</li> </ul>	<ul style="list-style-type: none"> <li>○ <u>Scholars Hallways and Stairs to Lunch</u>: Scholars walk in the hallway in one solid line, and once they reach stairs, stay in one line down the stairs. (<u>Lunch is the only time scholars will not split on the stairs</u>).</li> <li>○ Transition down stairs as follows: -K, 1<sup>st</sup>, 3<sup>rd</sup> Grades: Right side of stairs -2<sup>nd</sup>, 4<sup>th</sup> Grades: Left side of stairs</li> <li>○ Transition silently in HALLS, stopping at every stop sign with hand on the rail.</li> <li>○ Get one pump of Hand Sanitizer from dispenser at Cafeteria threshold.</li> <li>○ Say PETS Y words when retrieving their tray.</li> <li>○ If own lunch, <u>stay in single class line until at front of service line. Then, scholar walks off the line, up middle isle, to their seat.</u></li> <li>○ Walk on the inside aisle to get to their lunch table: -K, 1<sup>st</sup>, 3<sup>rd</sup>: Blue line -2<sup>nd</sup> &amp; 4<sup>th</sup>: Red line</li> <li>○ Show nonverbal signal to be dismissed to the washroom and walk up center isle.</li> </ul>	<ul style="list-style-type: none"> <li>○ <b>Monitors</b>: Model silence for scholars, and use nonverbal cues to redirect and redirecting with whispers only when necessary.</li> <li>○ <b>Monitors and Expeditors</b>: Absolute Silence! Refrain from talking to each other or be on cell phones as their attention should be on monitoring and reinforcing expectations for silence.</li> <li>○ <b>Monitors</b>: If your table has yet to arrive, be proactive! Circulate at tables that have scholars.</li> <li>○ <b>Monitors: Actively move</b> between the two tables, constantly scanning and reinforcing expectations for silence, assisting with opening packages, or encouraging scholars to eat.</li> <li>○ <b>Monitors</b>: Place REACH bar for the class on the column between the class' tables</li> <li>○ <b>Expeditor</b> is responsible for monitoring voices and scholars for the remaining 25 scholars closest to the line.</li> <li>○ <b>Expeditor</b> is responsible for placing all items on all scholar's trays</li> <li>○ <b>Expeditor</b>: All scholars must get all foods unless their name is displayed on allergy list.</li> <li>○ <b>Expeditor is responsible for tracking scholars not eating school lunch</b> by removing their name tags from class board.</li> <li>○ <b>Monitors</b>: Remind scholars that washrooms are closed until all scholars are seated unless otherwise noted by Lunch Lead.</li> <li>○ <b>Lunch Lead</b>: Monitors the first 4 tables while Expeditors are running the line.</li> <li>○ <b>Lunch Lead</b>: Actively narrates good scholar habits in line.</li> </ul>

Lunch Service Line

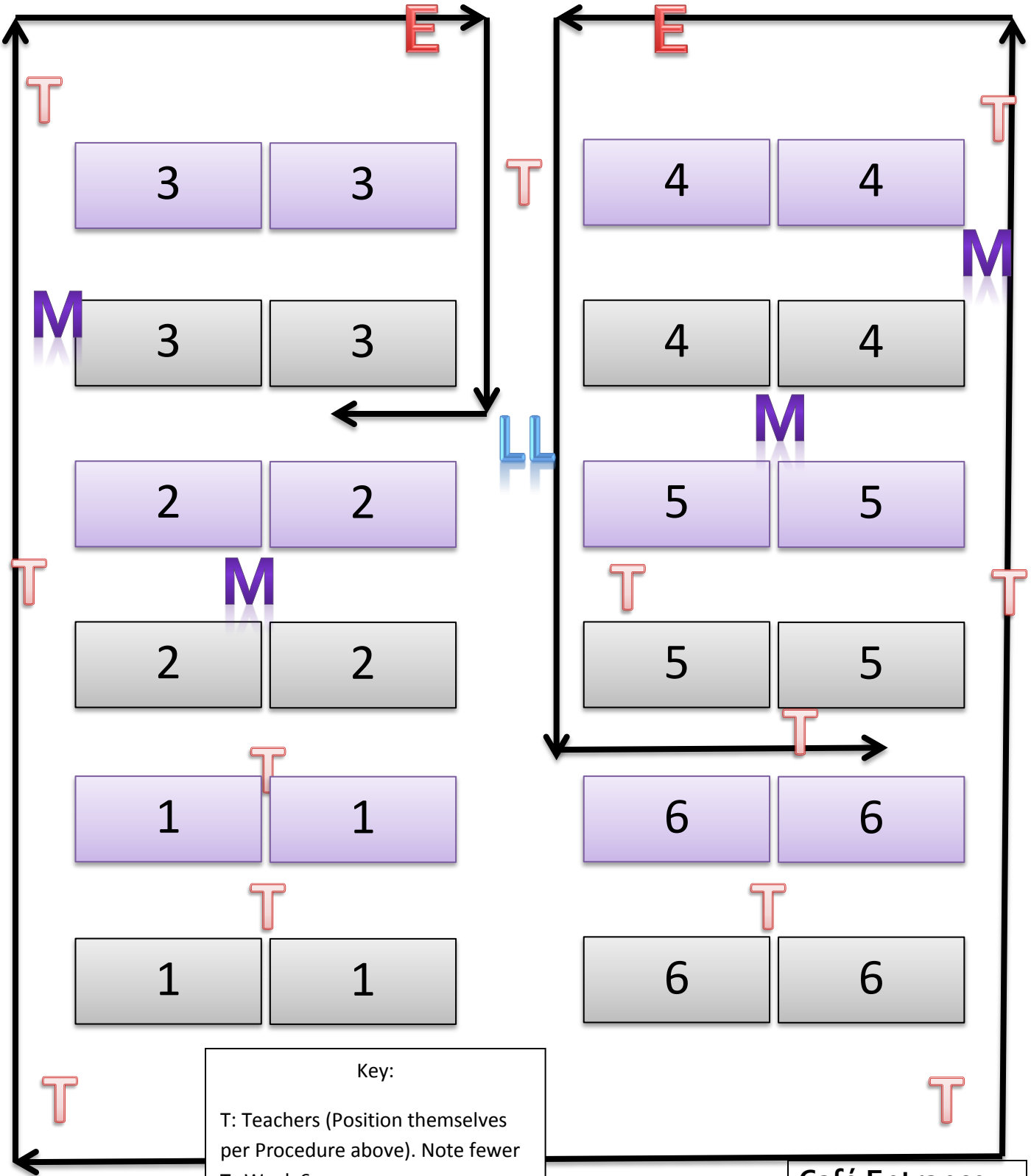

Key:

T: Teachers (Position themselves per Procedure above). Note fewer Ts Week 6+.

M: Monitors

LL: Lunch Lead

Café Entrance



**Diagram of Entrance into the Cafeteria:**

Scholars are lined up in single file lines of 22 or 30 on the stairs that lead to the cafeteria.

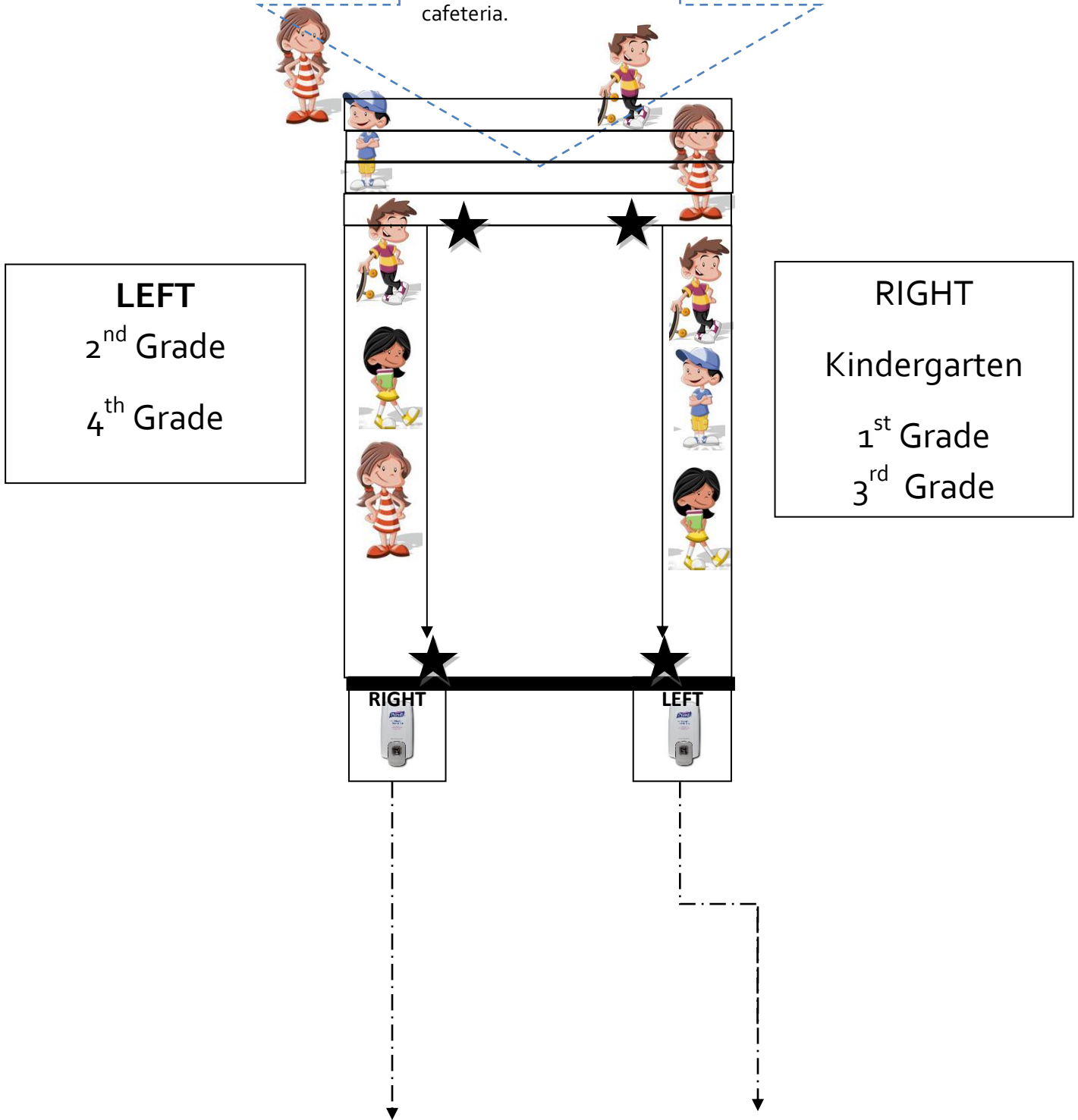

# School-wide Routine: Lunch Table Expectations

Ownership, Accountability and Preparedness	
<p><b>Overseen by:</b> Dean as Lunch Lead <b>Owner(s):</b> Teachers (transition and drop-off), Lunch monitors (during lunch)</p> <p><b>Non-Negotiables:</b></p> <ul style="list-style-type: none"><li>○ The transition to lunch is silent.</li><li>○ We have 7 staff members on lunch.<ul style="list-style-type: none"><li>○ Expeditor: on fruit/milk and lunch count (2)</li><li>○ Monitor: one person for 4 tables/across the aisle (3)</li><li>○ Monitor: one stationed at Washroom</li><li>○ Lunch Lead</li></ul></li><li>○ All teachers are on during the transition.</li><li>○ After Week 6 one Teacher stays while scholars move through the line to their seats.<ul style="list-style-type: none"><li>○ The first 4 weeks of school will be all hands on deck with a gradual release of control to the lunch monitors.</li></ul></li><li>○ Scholars sit 4 to a bench.</li><li>○ Corrections and relationships building with scholars will be done non-verbally in the first month of school to model and reinforce silence in the lunch room.</li></ul>	<p><b>Materials:</b></p> <ul style="list-style-type: none"><li>○ REACH Bar</li><li>○ Scholar name plates to track those eating lunch</li><li>○ Lunches for those who brought them into school</li><li>○ Scholar Dollars</li></ul>

### Lunch Table Expectations Procedure:

Teachers I & II	Scholars	Lunch Monitors, Expeditors, Lunch Lead
<ul style="list-style-type: none"> <li>○ <b>Week 1-6: Both Teachers</b> stay with class throughout lunch</li> <li>○ <b>Week 6+: One Teacher</b> stays with class until all scholars are seated at the table.</li> </ul>	<ul style="list-style-type: none"> <li>○ Walk on the inside aisle to get to their lunch table: -K, 1<sup>st</sup>, 3<sup>rd</sup>: Blue line -2<sup>nd</sup> &amp; 4<sup>th</sup>: Red line</li> <li>○ <b>Week 0-4:</b> Remain silent during lunch.</li> <li>○ <b>Week 4+:</b> Per Lunch Lead's recommendation, scholars may earn talk time at lunch.</li> <li>○ Scholars will have assigned lunch seats, identical to their line order.</li> <li>○ Scholars sit 4 to a bench.</li> <li>○ Scholars keep their napkin on their lap while they eat and safely reach to grab napkin, should it fall.</li> <li>○ Scholars should not share food to eliminate jealousy and the possibility of a scholar eating something they are allergic to.</li> <li>○ August-February: Scholars have 3 chances to manage their volume before their table moves to silence.</li> <li>○ <b>Last 3-5m of lunch:</b> Silent for scholars to finish lunch.</li> </ul>	<ul style="list-style-type: none"> <li>○ <b>Monitors:</b> Model silence for scholars, and use nonverbal cues to redirect and redirecting with whispers only when necessary.</li> <li>○ <b>Monitors and Expeditors:</b> Absolute silence! Refrain from talking to each other or be on cell phones as their attention should be on monitoring and reinforcing expectations for silence.</li> <li>○ <b>Monitors: Actively move</b> between the two tables, constantly scanning and reinforcing expectations for silence, assisting with opening packages, or encouraging scholars to eat.</li> <li>○ <b>Monitors:</b> Scan for scholars to have feet flat, bodies turned toward their food, silent and eating.</li> <li>○ <b>Monitors:</b> Remind scholars to place napkin on their lap as they eat.</li> <li>○ <b>Monitors:</b> Place REACH bar for the class on the column between the class' tables</li> <li>○ <b>Monitors:</b> Dismisses scholars to the restrooms showing the signal.</li> <li>○ <b>Monitors:</b> Hold scholars accountable to silence with the REACH bar and rationale, using a whisper correction.</li> <li>○ <b>Expeditor is responsible for tracking scholars not eating school lunch</b> by removing their name tags from class board.</li> <li>○ <b>Lunch Lead:</b> Monitors the first 4 tables while Expeditors are running the service line.</li> <li>○ <b>Lunch Lead:</b> Actively narrates good scholar habits.</li> <li>○ <b>Lunch Lead:</b> Monitor scholar volume and provide reminder with 3 chances before silent lunch.</li> </ul>



Lunch Service Line

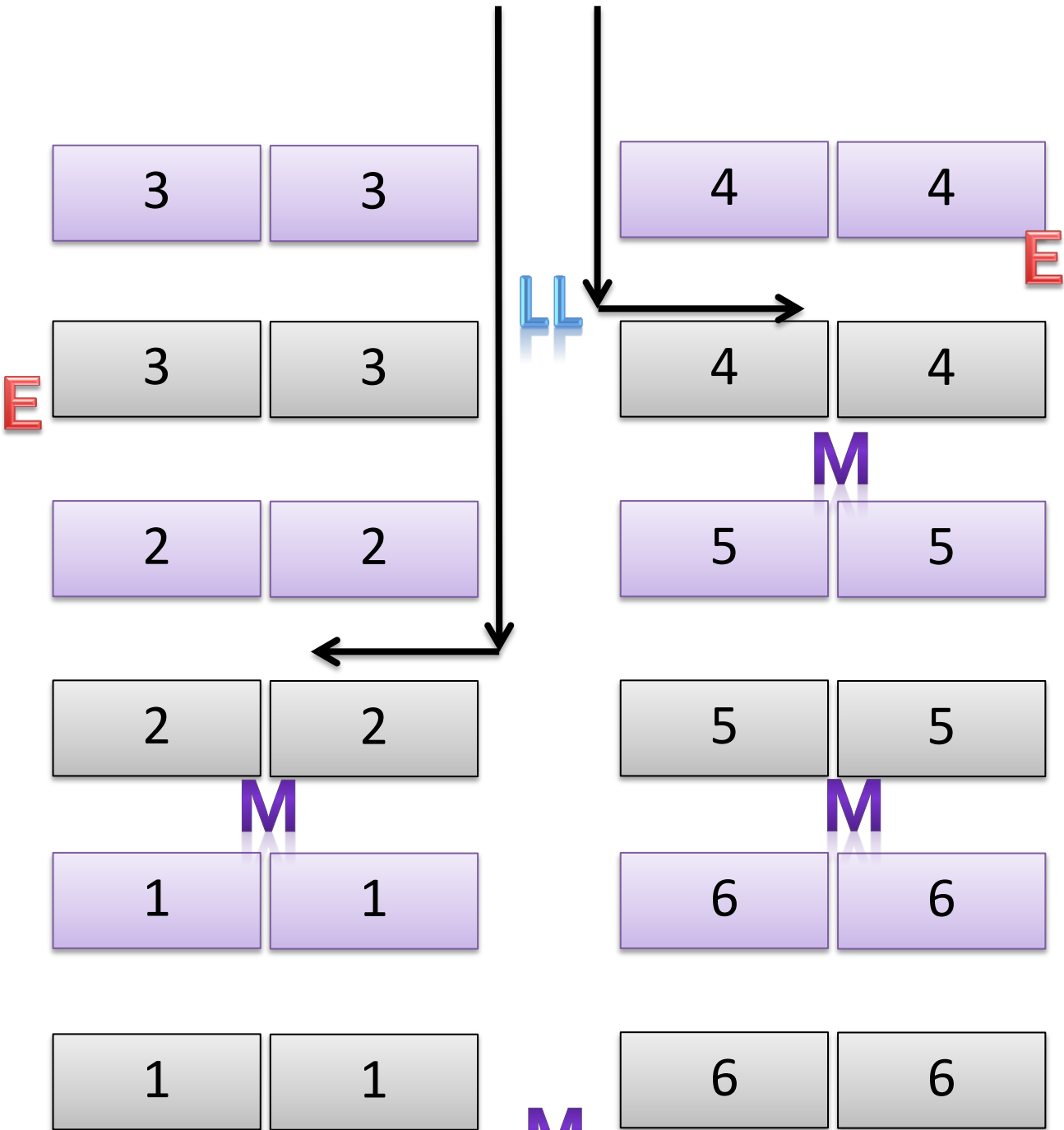

Key:

M: Monitors                      E: Expeditors

LL: Lunch Lead

→ :Scholars

Café Entrance

# School-wide Routine: Lunch Clean-Up

Ownership, Accountability and Preparedness	
<p><b>Overseen by:</b> Dean as Lunch Lead</p> <p><b>Owner(s):</b> Teachers (transition), Lunch monitors (during lunch)</p> <p><b>Non-Negotiables:</b></p> <ul style="list-style-type: none"><li>○ The lunch room is 100% silent during clean-up and dismissal for scholars and teachers.</li><li>○ Teachers will use nonverbal CORRECTIONS. Whisper correct if necessary. If you must use your voice, take scholar out of the cafeteria</li><li>○ Scholars clean up all crumbs and garbage.</li><li>○ If scholar doesn't bring a lunch, remind them to put trash on neighbor's tray.</li><li>○ Transitioning teachers should arrive at their specified time to promptly pick up their class.</li><li>○ Monitors and teachers rely on Be Seen Looking, Proximity, Circulate, Nonverbal and Corrections</li><li>○ Monitors and Teacher stops at all stopping points to monitor lines.</li></ul>	<p><b>Materials:</b></p> <ul style="list-style-type: none"><li>○ REACH Bar</li><li>○ Scholars who brought their lunch take it back with them to their classroom</li><li>○ Scholar Dollars</li></ul>

### Lunch Clean Up Procedure:

Teachers I & II	Scholars	Lunch Monitors, Expeditors, Lunch Lead
<ul style="list-style-type: none"> <li>○ <b>Week 1-6: Both Teachers</b> stay with class throughout lunch. Silently, reinforce Lunch Lead's expectations.</li> <li>○ <b>Week 6+:</b> <b>One Teacher</b> arrives in time for Lunch Clean Up. Silently, reinforce Lunch Lead's expectations.</li> </ul>	<ul style="list-style-type: none"> <li>○ When call to attention is heard, scholar's finish lunch quickly and silently.</li> <li>○ Scholars close their milk carton and put all trash on their trays with enough room to SLANT on top of the table, and sit in SLANT.</li> <li>• The scholars will be taught the following procedure:               <ul style="list-style-type: none"> <li>○ "It's time to transition back to class.</li> <li>○ "One": One leg over bench. Hands in SLANT with one elbow on table. Eyes on Lunch Lead.</li> <li>○ "Two": Both legs over the bench, hands in SLANT in your lap. Eyes on Lunch Lead</li> <li>○ "Three": Stand, facing the table. Hands by your side. Eyes on Lunch Lead</li> <li>○ "Four": Track your arrow. Look at the directions you will turn. Pick Up Tray and turn safely in the direction of your arrow. Eyes forward. Silently wait for signal.</li> <li>○ Track the cafeteria staff with your eyes only, "What do we say to those who served us today?" <b>Scholars say: Thank you for the food you prepared. Have a great day."</b></li> <li>○ Scholars, you have a good day": Is the signal to transition out and throw away trash.</li> </ul> </li> <li>• Kindergarten: Milks will be taken off of the trays in Weeks 1-6. Milks will be added to trays closed when they have the routine for dismissal firm.</li> <li>• Grades 1-4: Milks will always be thrown away by the scholar.</li> </ul>	<ul style="list-style-type: none"> <li>○ <b>5 Minutes Before End of Lunch:</b></li> <li>○ <b>Lunch Lead:</b> 5 minutes before the end of lunch, the Lead will call "Monitors" and hold up the number '2', alerting them of clean up in 2 minutes.</li> <li>○ <b>Monitors:</b> Prepare your tables for clean-up.</li> <li>○ <b>Monitors:</b> Remind scholars to pick up all trash found around their person as they eat and prepare to clean up.</li> <li>○ <b>Lunch Lead:</b> Call scholars to attention with clap rhythm.</li> <li>○ Clean-up begins 1 minute before lunch dismissal time.</li> <li>○ The transition for dismissal begins when all scholars are silent and in SLANT with all trash on tray. The <b>lunch monitor</b> and <b>homeroom teachers</b> support with all hands on deck at this time.</li> </ul>

## School-wide: Lunch Dismissal/Transition Out of the Cafeteria

Ownership, Accountability and Preparedness	
<p><b>Overseen by:</b> Dean as Lunch Lead</p> <p><b>Owner(s):</b> Homeroom teachers, lunch monitors</p> <p><b>Non-Negotiables:</b></p> <ul style="list-style-type: none"><li>○ The transition out of the cafeteria and in hallways is 100% silent for Teachers and Scholars.</li><li>○ Teachers and Monitors rely on Be Seen Looking, Proximity, Circulate, Nonverbal and Whisper redirects.</li><li>○ Teacher stops at all stopping points to monitor lines.</li><li>○ Each classroom transitions out in 2 lines from the lunch room in preparation for the stairwells. Once they reach their respective hallway, create one line of 30.</li><li>○ Scholars will be</li><li>○ <b>Teacher Positioning:</b><ul style="list-style-type: none"><li>○ In the stairwell: Teacher I at front, Teacher II at the end of the two lines.</li><li>○ In the hallway: Teacher I at front, Teacher II in the middle of line.</li></ul></li></ul>	<p><b>Materials:</b></p> <ul style="list-style-type: none"><li>○ REACH Bar</li><li>○ Scholar Dollars</li></ul>



### Lunch Dismissal/Transition Out of the Cafeteria Procedure:

See diagram below for pathway out of cafeteria, stairwell to utilize, and specific stopping points for each class.

Teachers I & II	Scholars	Lunch Monitors, Expeditors, Lunch Lead
<ul style="list-style-type: none"> <li>○ <b>Week 1-6: Both Teachers</b> stay with class throughout lunch. Silently, reinforce Lunch Lead's expectations.</li> <li>○ <b>Week 6+:</b> Teacher I stand at front of cafeteria tables midway between two tables. Teacher II circulates to ensure all scholars are in SLANT and tracking Lunch Lead.</li> <li>○ Teacher I should not use voice to get scholar's to track them. Tracking should happen as soon as Lunch Lead says, "Have a good day". Teacher II should non-verbally remind any non-tracking scholars.</li> <li>○ Teacher I leads line. Teacher II stands at the back of the line then follows last two students at the end of the line.</li> <li>○ Teachers silently lead lines to all stopping points, inspect line, get the thumbs up from their co-teach, and then continue to the next stopping point.</li> <li>○ Teacher II must signal Teacher I with a thumbs up to communicate line is ready to move and correct using non-verbals. Any correction is tracked on the REACH bar, with teachers non-verbally communicating corrections to each other.</li> <li>○ Note: Scholars will NOT be in specific morning line order.</li> </ul>	<ul style="list-style-type: none"> <li>● When call to attention is heard, scholar's finish lunch quickly and silently.</li> <li>● Scholars close their milk carton and put all trash on their trays with enough room to SLANT on top of the table, and sit in SLANT.</li> <li>● *The scholars will be taught the following procedure:             <ul style="list-style-type: none"> <li>○ "It's time to transition back to class. "One": Leg over the bench. Hands in SLANT with one elbow on table. Eyes on Lunch Lead.</li> <li>○ "Two": Both legs over the bench, hands in SLANT in your lap. Eyes on Lunch Lead</li> <li>○ "Three": Stand, facing the table. Hands by your side. Eyes on Lunch Lead</li> <li>○ "Four": Pick Up Tray and turn safely in the direction you walk. Use arrow as reminder. Eyes forward. Silently wait for signal.</li> <li>○ What do we say to those who served us today?" <b>Scholars say: Thank you for the food you prepared for us. Have a great day!"</b></li> <li>○ "Have a good day": Is the signal to transition out and throw away trash.</li> </ul> </li> <li>● Scholars will transition out forming 2 lines using their designated pathway.</li> <li>● Kindergarten: Milks will be taken off of the trays in Weeks 1-6. Milks will be added to trays closed when they have the routine for dismissal firm.</li> <li>● Grades 1-4: Milks will always be thrown away by the scholar.</li> <li>● Scholars transition out from table as shown in diagram below</li> </ul>	<ul style="list-style-type: none"> <li>○ <b>Monitors:</b> Remind scholars to pick up any trash near them as they throw trash away.</li> <li>○ <b>Monitors:</b> Be extra eyes and reinforce expectations of Lunch Lead</li> <li>○ <b>Monitors:</b> Throw away any trash left on the tables.</li> <li>○ <b>Monitors:</b> After each cue from Lunch Lead, reinforce expectations non-verbally and correct when necessary.</li> <li>○ <b>Lunch Lead:</b> Dismiss using the procedure * in Scholars column.</li> </ul>

	<ul style="list-style-type: none"><li>• Lines then move up stairs and stop at each stopping point to be inspected.</li><li>• Note: Due to table dismissal, scholars will NOT be in specific class seat order as they dismiss from lunch.</li></ul>	
--	--	--

# Lunch Service Line

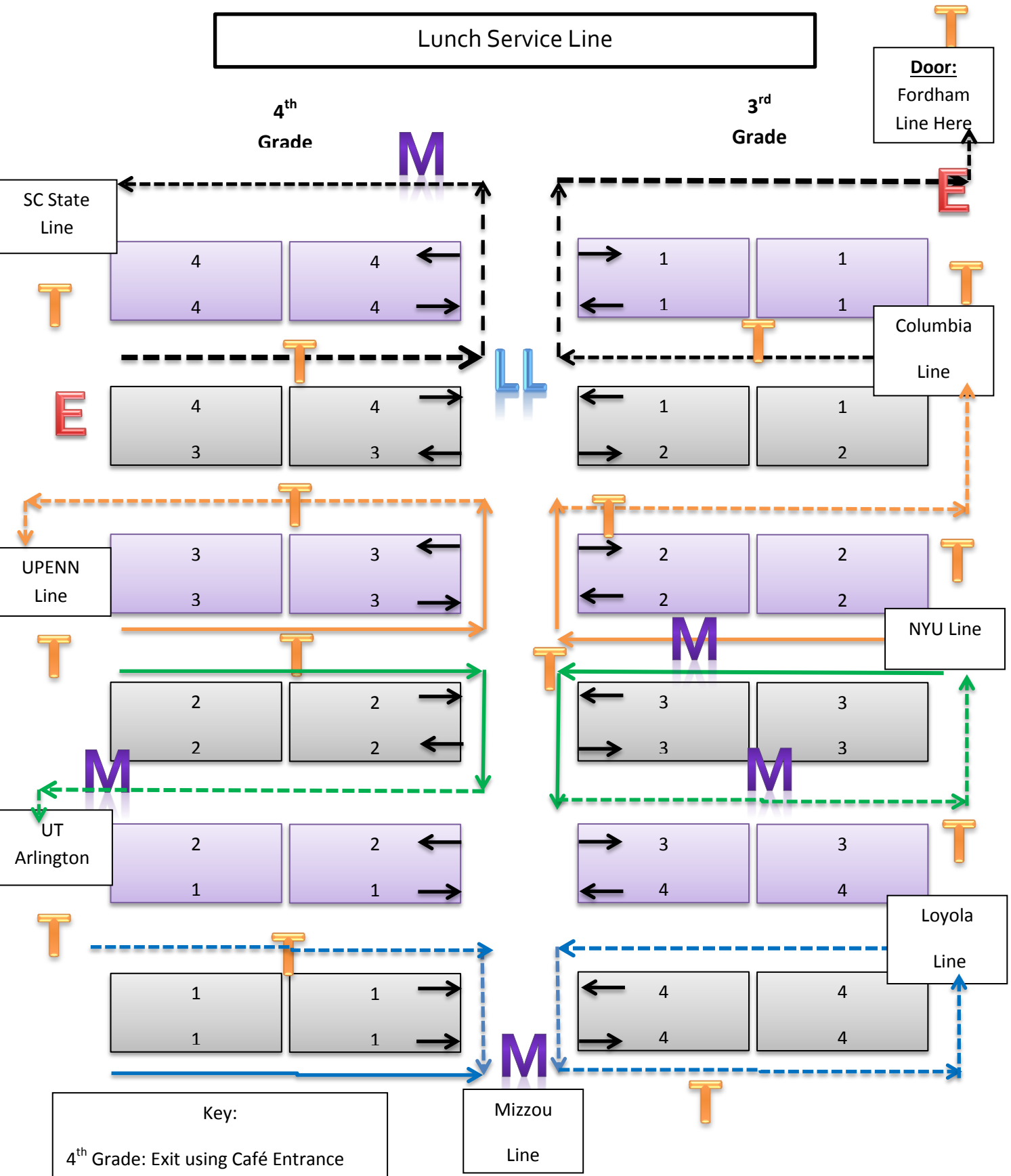

**Key:**

4<sup>th</sup> Grade: Exit using Café Entrance

3<sup>rd</sup> Grade: Exit using Back staircase

Double lines, marked with →

Single lines, marked with →

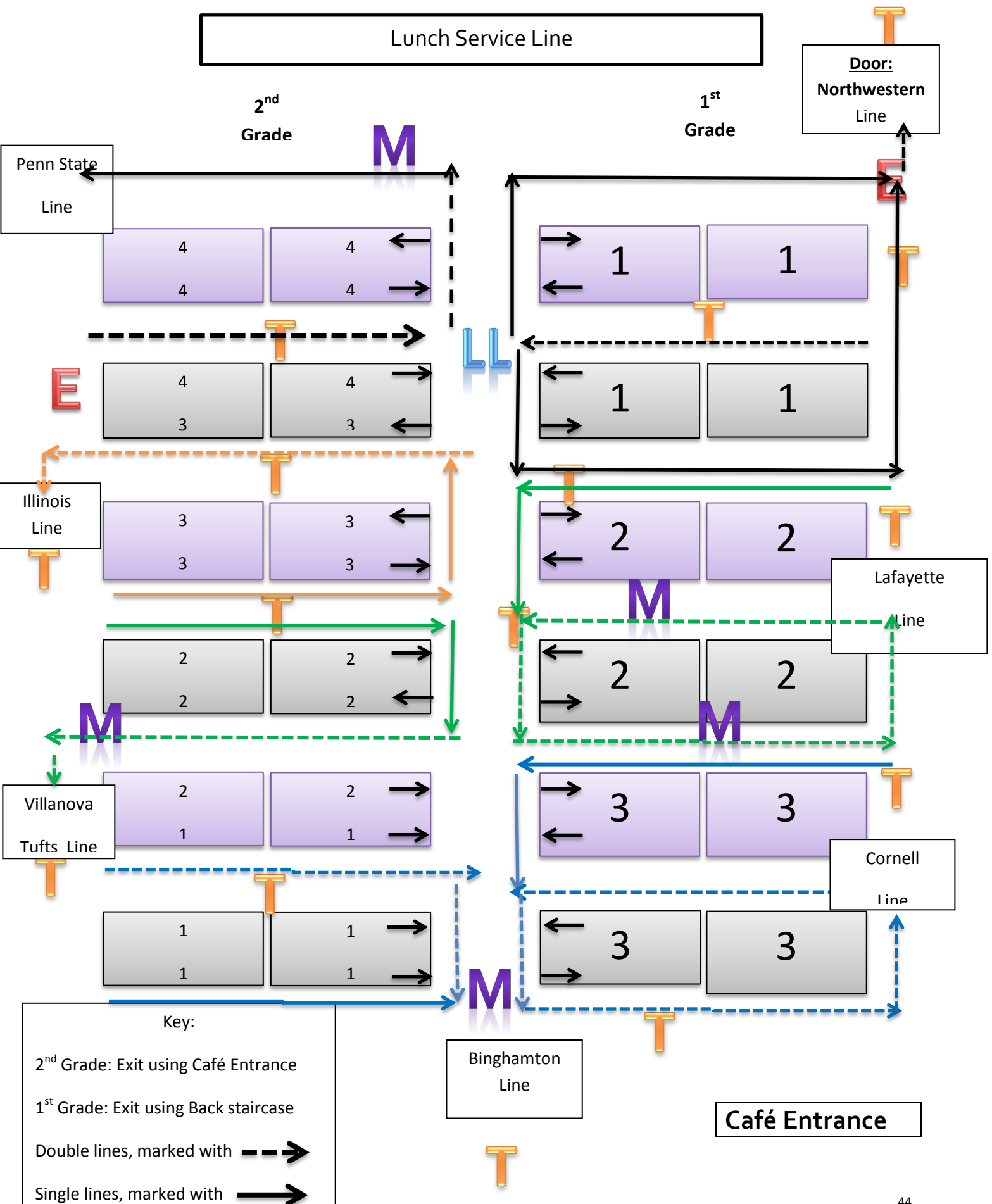

Lunch Service Line

Kindergarten

Door: St. Joes Line

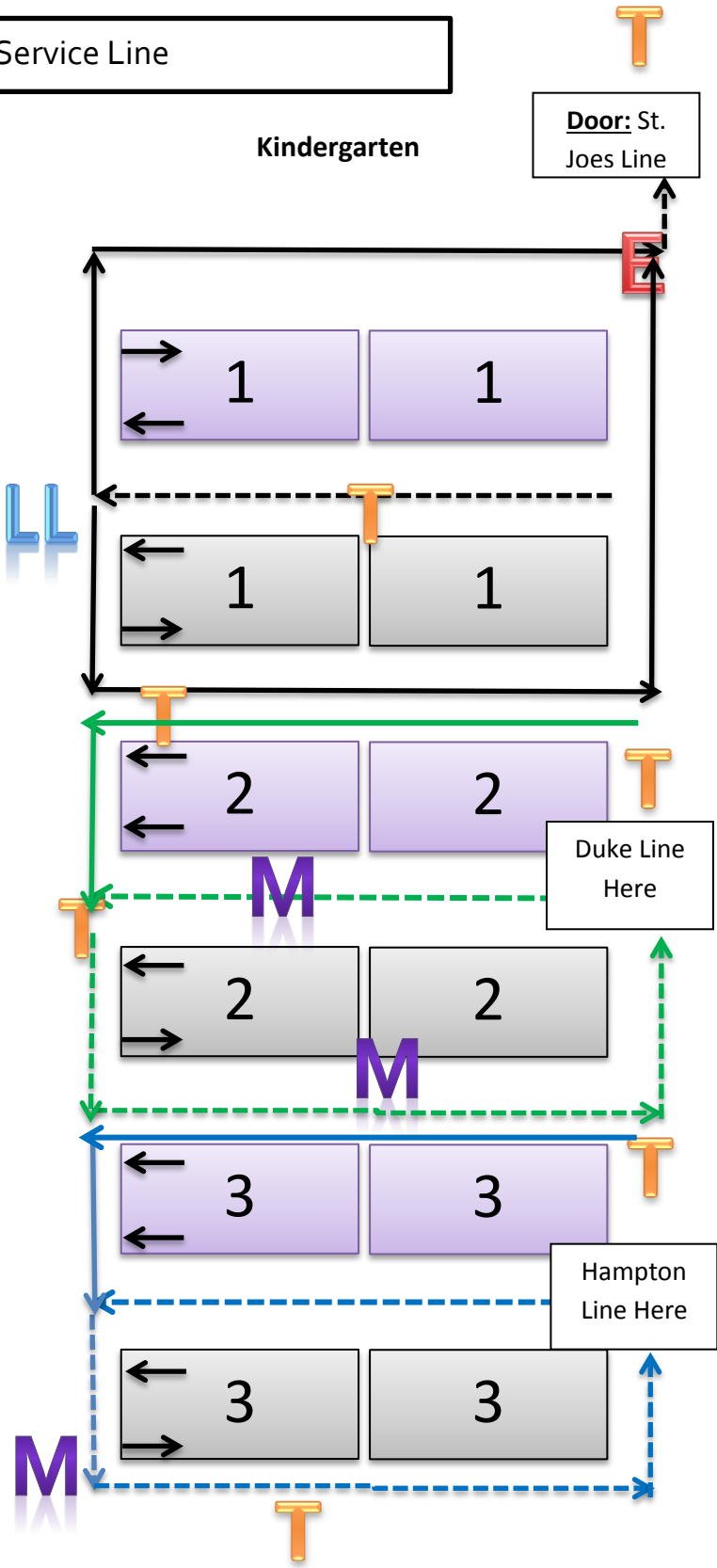

Key:

Kindergarten: Exit using Back staircase

Double lines, marked with 

Single lines, marked with 

Café Entrance

# School-wide: Transition from Desks to Rug

## Ownership, Accountability and Preparedness

**Overseen by: Deans and Principal**

**Owner(s): Classroom Teachers, Interventionists, Learning Specialist**

### Non-Negotiables:

- Transitions are 100% silent.
- Teacher(s) stand at designated position to lead transition (in front of the class, in front of rug, etc.). Co-teachers position themselves in the front and rear of the room to check for compliance at all times.
- Teacher cuing is crisp with immediate scholar responses and 100% compliance.
- Precise student actions are scanned for and corrected with a quick Do It Better and Corrections if expectations are not met.
- Designated pathways for each grade level are universal throughout each room, scholars travel along that pathway without confusion.
- Teacher uses non-verbals to transition their class, no words necessary to correct behavior.
- 30 seconds or less, using a timer and not teacher counting.
- Immediate. Transitions occur flawlessly between lessons and there is not a "lead up" or narration around the transition.
- Scholars walk along pathway until their actual rug color and turn sharply to walk **ONLY** on their rug color.
  
- **Teacher Positioning:**
  
- **One Teacher:** Teacher starts transition at the head of the desks, walks backwards over the rug before first scholar is seated.
  
- **Two Teachers:** Teacher I leads transition from in front of the desks, Teacher II is assisting with SLANT and the steps to stand up from the desk. Before scholars transition to the rug, Teacher II ensures all scholars are standing in HALL, eyes facing their respective direction, and are ready to move. Teacher I walks backwards across the rug to continue scanning as scholars transition before the first scholar is seated.

### Materials:

- Timer
- Tape for pathways
- Transition chart to record times earned
- REACH Bar
- Scholar Dollars

**Procedure Bellwether I: 8/19-9/4** - Teacher directed with narration, mechanical student actions.

Teacher will teach scholars the 5 signaled steps to transitioning using the **exact narration below**, and do-it-better language.

- After modeled and each step is practiced, the entire transition should take 3 minutes.
- Teacher says, “We are transitioning to the rug.”
- Teacher cues using these signals:

Signal	Teacher Language	Teacher Action	Student Action
Before Transition	<b>“Backs tall, hands folded, eyes, tracking.”</b>	Ensure 100% SLANT and tracking, positioned at the front of the room scanning. <b>Behavioral Narration of specific actions that show ready to transition.</b>	100% in SLANT and tracking
Timer	Our goal is to transition in __ minutes.	Start timer.	Tracking for first cue.
Closed fist	<b>“Knees turn to window, ZERO”</b>	Lift arm from side in a fist, straight above head, scan for compliance <b>Behavioral Narration of specific actions (X has knees facing window, sounds off, eyes tracking cue, hands folded in SLANT on the desk.”</b>	Scholars move their knees to right, in SLANT and tracking. Feet are flat on the ground.
One finger	<b>“Stand, ONE”</b>	Arm still above head, show one finger, scan for compliance <b>Behavioral Narration of specific actions (X has eyes tracking cue, sounds off.”)</b>	Scholars stand in HALL, without taking any steps beside their chair.
Two fingers	<b>“Push in, hands on chair, TWO”</b>	Arm still above head, show two fingers, scan for compliance <b>Behavioral Narration of specific actions (“X Pushed in safely on cue, hands on chair, sounds off, eyes tracking cue.”)</b>	Scholars push in chair with minimal sound and stand behind with their hands on the backs of their chair.
Three fingers	<b>“Turn, THREE”</b>	Arm still above head, show three fingers, and scan for compliance. <b>Behavioral Narration of specific actions (“X has hands by side, eyes still tracking, body turned safely.”)</b>	Scholars turn and face their respective direction to transition in HALL (see flow chart below)
*Snap*	<b>“Transition, *snap*”</b>	Teacher gives audible snap to begin transition. <b>Behavioral Narration of specific actions (“X is walking in HALLS, sounds off, walking on pathway, moving with the spirit.”)</b>	Scholars walk to the carpet, filing in opposite directions 2 rows at a time.
At carpet	Teacher scans for safety when walking, and walking on pathway, no cutting	Modeling scholars to sit in SLANT <b>Behavioral Narration of specific actions (“X is seated criss cross apple sauce, hands locked.”)</b>	Scholars walk along the pathway until they reach their row color, turn and walk only on their row color and sit once they are in the center of their square.

	through rug.		
Do It Better	<p>Tell scholars:</p> <ol style="list-style-type: none"> <li>1. Be seated or face forward in SLANT.</li> <li>2. State exactly what was wrong</li> <li>3. Tell/show the right way</li> <li>4. Immediately start signal to try again.</li> </ol> <p>i.e.: "Scholars, be seated, I noticed some friends did not have their hands on the backs of chairs. Both hands are placed on the back of your *chair*. Let's do it!" Show closed fist. (And move through procedure accordingly.)</p>		

**Procedure 2<sup>nd</sup> Bellwether: 9/7-9/18:** Reduced teacher narration and non-verbals for the numbers, automatic student actions

Teacher will teach scholars the 5 signaled steps to transitioning using the **minimal** narration below, and do-it-better language.

- K-1: After modeled and each step is practiced, the entire transition should take 1.5 minutes.
- 2: After modeled and each step is practiced, the entire transition should take 1 minutes.
- Teacher says, "We are transitioning to the rug."
- Teacher cues using these signals:

Signal	Teacher Language	Teacher Action	Student Action
Before Transition	<b>"SLANT Check."</b>	Ensure 100% SLANT and tracking, positioned at the front of the room scanning.	100% in SLANT and tracking
Timer	Our goal is to transition in __ minutes.	Start timer.	Seated in SLANT.
Closed fist	Say <b>"knees"</b> , show closed fist.	Lift arm from side in a fist, straight above head, scan for compliance.	Scholars move their knees to right, in SLANT and tracking. Feet are flat on the ground.
One finger	Say <b>"stand"</b> , show one finger.	Arm still above head, show one finger, scan for compliance	Scholars stand in HALL, without taking any steps beside their chair.
Two fingers	Say <b>"chair"</b> , how two fingers.	Arm still above head, show two fingers, scan for compliance	Scholars push in chair with minimal sound and stand behind with their hands on the backs of their chair.
Three fingers	Say <b>"turn"</b> , show three fingers.	Arm still above head, show three fingers, scan for compliance	Scholars turn and face their respective direction to transition in HALL (see flow chart below)
*Snap*	<b>"Transition,</b>	Teacher gives audible snap to begin transition.	Scholars walk to the carpet, filing in opposite



	<b>*snap*</b>		directions 2 rows at a time.
At carpet	Teacher scans for safety when walking, and walking on pathway, no cutting through rug.	Modeling scholars to sit in SLANT, pointing to scholars seated in SLANT and saying "yes."	Scholars walk along the pathway until they reach their row color, turn and walk only on their row color and sit once they are in the center of their square.
Do It Better	<p>Tell scholars:</p> <ol style="list-style-type: none"> <li>1. Be seated or face forward in SLANT.</li> <li>2. Using economy of language, state a one word correction, "eyes"</li> <li>3. Tell/show the right way</li> <li>4. Immediately start signal to try again.</li> </ol> <p>i.e.: "Scholars, be seated, let's remember all eyes on me. Let's do it!" Show closed fist. (And move through procedure accordingly.)</p>		

**Procedure 3<sup>rd</sup> Bellwether: 9/21-10/2:** Zero teacher narration, all **non-verbals**, and internalized scholar habits

- Transition should take 30 seconds.
- Teacher says, “We are transitioning to the rug.”

Signal	Teacher Language	Teacher Action	Student Action
Before Transition	<b>“SLANT”</b>	Ensure 100% SLANT and tracking, positioned at the front of the room scanning.	100% in SLANT and tracking
Timer	Point to timer; give a thumbs up and enthusiastic smile. Imply with your body language it’s time for them to “show off.”	Press timer	Tracking for first cue.
Closed fist	None	Lift arm from side in a fist, straight above head.	Scholars move their knees to right, in SLANT and tracking. Feet are flat on the ground.
One finger	None	Arm still above head, show one finger	Scholars stand in HALL, without taking any steps beside their chair.
Two fingers	None	Arm still above head, show two fingers	Scholars push in chair with minimal sound and stand behind with their hands on the backs of their chair.
Three fingers	None	Arm still above head, show three fingers	Scholars turn and face their respective direction to transition in HALL (see flow chart below)
*Snap*	None	Teacher gives audible snap to begin transition.	Scholars walk to the carpet, filing in opposite directions 2 rows at a time.
At carpet	Teacher scans for safety when walking, and walking on pathway, no cutting through rug.	Modeling scholars to sit in SLANT and giving only non-verbal thumbs up, points, and smiles.	Scholars walk along the pathway until they reach their row color, turn and walk only on their row color and sit once they are in the center of their square.
Do it Better	Tell scholars: <ol style="list-style-type: none"> <li>1. Be seated or face forward in SLANT.</li> <li>2. Stare at the scholar not in compliance, use proximity if necessary, move clip.</li> <li>3. Immediately start signal to try again.</li> </ol>		

	I.e.: Say, "Be seated" (nodding head no, motion to sit). Using your best square up look at the non-complier, non-verbal them and move their clip, and then show a closed fist to start again. (move through procedure accordingly)
--	--

# Diagram for Desk to Rug

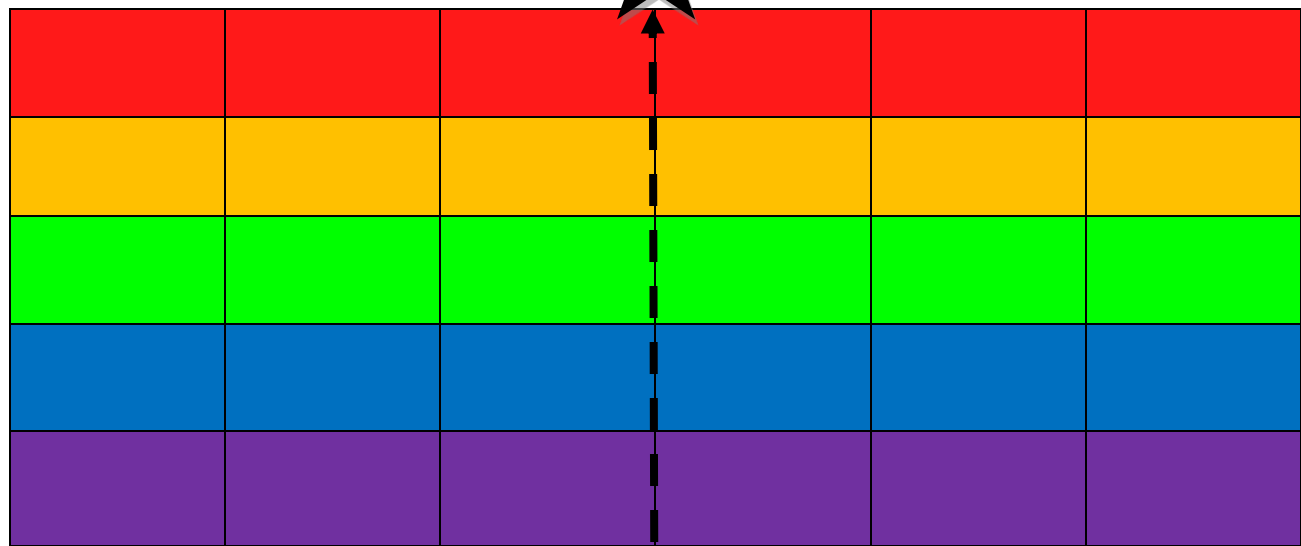

Teacher position notated with stars.  
Teacher I will start transition at the front of desks, then move backwards as scholars travel to the rug.



Lines transition simultaneously:  
-Red and orange together  
-Green and blue together  
-Purple transitions last

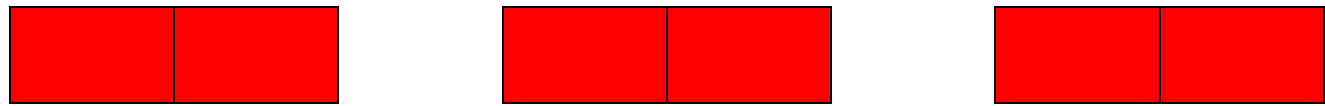

1<sup>st</sup>

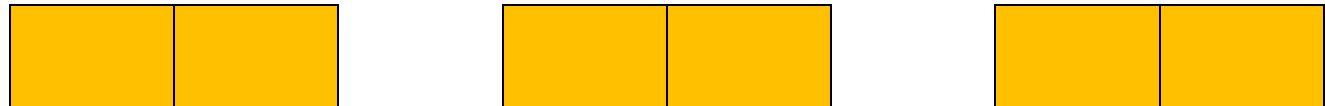

1<sup>st</sup>



2<sup>nd</sup>



2<sup>nd</sup>



3<sup>rd</sup>

Door

# School-wide: Transition from Rug to Desks

## Ownership, Accountability and Preparedness

Overseen by: Deans and Principal

Owner(s): Classroom Teachers, Interventionists, Learning Specialist

### Non-Negotiables:

- Create a row spots chart for the rug with each scholar's name in an individual square (see sample below).
- Use tape to mark the pathway from rug to desks
- Transitions are 100% silent, until they meet the following criteria during every transition throughout the day and scholars have internalized transitions into muscle memory.
  - Teacher(s) stand at designated position to lead transition (in front of the class, in front of rug, etc.)
  - Teacher cuing is crisp with immediate scholar responses and 100% compliance.
  - Precise student actions are scanned for and corrected with a quick Do It Better if expectations are not met.
  - Designated pathways for each grade level are universal throughout each room, scholars travel along that pathway without confusion.
  - Teacher uses non-verbals to transition their class, no words necessary to correct behavior.
  - Silent. Scholars do not chant/cheer/count, all voices are silent.
  - 30 seconds or less, using a timer and not teacher counting.
  - Immediate. Transitions occur flawlessly between lessons and there is not a "lead up" or narration around the transition.
- **Teacher Positioning:**
  - **(One Teacher)** After teacher starts transition from rug, move to the side of the rug near the green row to monitor both the carpet and the desks, then to the front of the desks once transition is complete.
  - **(Two Teachers)** Teacher I is at the front of the rug, Teacher II meets scholars back at their desks and are walking back and forth along the aisles and through desks to monitor transition.

### Materials:

- Timer
- Tape for pathways
- Transition chart to record times earned
- REACH Bar
- Row spots chart
- Scholar Dollars

**Procedure 1<sup>st</sup> Bellwether: 8/19-9/4** Teacher directed with narration, mechanical student actions.

- Teacher will teach scholars the 5 signaled steps to transitioning using the **exact narration below**, and do-it-better language.
  - After modeled and each step is practiced, the entire transition should take 3m
- Teacher says, "We are transitioning to the rug."
- Teacher cues using these signals:

Signal	Teacher Language	Teacher Action	Student Action
Before Transition	<b>"Backs tall, hands folded, eyes, tracking."</b>	Ensure 100% SLANT and tracking, positioned at the front of the room scanning.	100% in SLANT and tracking
Timer	Our goal is to transition in __ minutes.	Start timer.	Seated in SLANT.
One finger	<b>"Stand in HALLS, ONE"</b>	Arm still above head, show one finger, scan for compliance	Scholars stand in HALLS in the middle of their square.
Two fingers	<b>"Turn to your arrow, TWO"</b>	Arm still above head, show two fingers, scan for compliance	Scholars turn and face their respective directions that they walk back to their seats.
*Snap*	<b>"Transition, *snap*"</b>	Teacher gives audible snap to begin transition.	Scholars walk to their desks, filing in opposite directions 2 rows at a time to stand in HALLS behind their seat.
At desks	Teacher scans for safety when walking, and walking on pathway, no cutting through rug. Teacher scans for scholars seated right to work or in SLANT waiting for directions.	Scanning for scholars getting right to work or SLANT for next directions.	Immediately sit down and begin work or SLANT for next directions.
Do It Better	Tell scholars: <ol style="list-style-type: none"> <li>1. Be seated or face forward in SLANT.</li> <li>2. State exactly what was wrong</li> <li>3. Tell/show the right way</li> <li>4. Immediately start signal to try again.</li> </ol> I.e.: "Scholars, be seated, I noticed some friends rotated in the incorrect direction. Point to where you see your rows arrow *snap* scholars point. Let's do it!" Show one. (And move through procedure accordingly.)		

**Procedure 2<sup>nd</sup> Bellwether: 9/7-9/18** Reduced teacher narration and non-verbals for the numbers, automatic student actions

- Teacher will teach scholars the 5 signaled steps to transitioning using the **minimal** narration below, and do-it-better language.
  - After modeled and each step is practiced, the entire transition should take 1.5 minutes.

Signal	Teacher Language	Teacher Action	Student Action
Before Transition	<b>"SLANT check"</b>	Ensure 100% SLANT and tracking, positioned at the front of the room scanning.	100% in SLANT and tracking
Timer	Our goal is to transition in __ minutes.	Start timer.	Seated in SLANT.
One finger	Say <b>"HALLS"</b> show one finger.	Arm still above head, show one finger, scan for compliance	Scholars stand in HALL in the middle of their square.
Two fingers	Say <b>"Turn"</b> , show two fingers	Arm still above head, show two fingers, scan for compliance	Scholars turn and face their respective directions that they walk back to their seats.
*Snap*	<b>"Transition, *snap*"</b>	Teacher gives audible snap to begin transition.	Scholars walk to their desks, filing in opposite directions 2 rows at a time to stand in HALL behind their seat.
At desks	Teacher scans for safety when walking, and walking on pathway, no cutting through rug. Teacher scans for scholars seated right to work or in SLANT waiting for directions.	Scanning for scholars getting right to work or SLANT for next directions.	Immediately sit down and begin work or SLANT for next directions.
Do It Better	Tell scholars: <ol style="list-style-type: none"> <li>1. Be seated or face forward in SLANT.</li> <li>2. State exactly what was wrong using economy of language.</li> <li>3. Tell/show the right way</li> <li>4. Immediately start signal to try again.</li> </ol> I.e.: "Be seated, I need all friends in HALLS. Let's do it!" Show one. (And move through procedure accordingly.)		

**Procedure 3<sup>rd</sup> Bellwether 9/21-10/2** Zero teacher narration, all non-verbals, internalized scholar habits

- Teacher will instruct scholars to follow the 5 signaled steps to transitioning from their desks to their rug seats, **non-verbally**. Scholar actions must be uniform and meet the non-negotiable criteria listed above.
  - Transition should take 30 seconds.

Signal	Teacher Language	Teacher Action	Student Action
Before Transition	<b>"SLANT"</b>	Ensure 100% SLANT and tracking, positioned at the front of the rug.	100% in SLANT and tracking
One finger	none	Arm still above head, show one finger	Scholars stand, without touching in the middle of their square in HALL.
Two fingers	none	Arm still above head, show two fingers	Scholars rotate to their respective directions to transition. (see flow chart below)
*Snap*	none	Teacher gives audible snap to begin transition.	Scholars file to desks in reverse order of how they filed into the rug (purple, blue & green, orange & red)
At desks	none	Scanning for scholars getting right to work or SLANT for next directions.	Immediately sit down and begin work or SLANT for next directions.
Do It Better	Tell scholars: <ol style="list-style-type: none"> <li>1. Be seated or face forward in SLANT.</li> <li>2. Stare at the scholar not in compliance, use proximity if necessary, move clip.</li> <li>3. Immediately start signal to try again. .</li> </ol> I.e.: "Take a seat." While making strong eye contact in square up position with non-complier. Move their clip and non-verbal what they need to do. Whisper correct if necessary. Show one. (Move through procedure accordingly.)		



Diagram for Rug to Desk

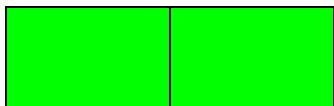
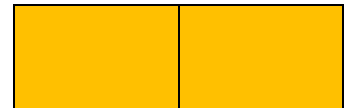
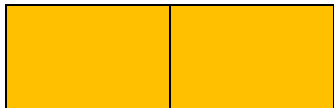
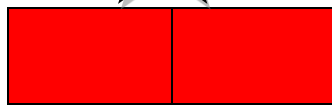
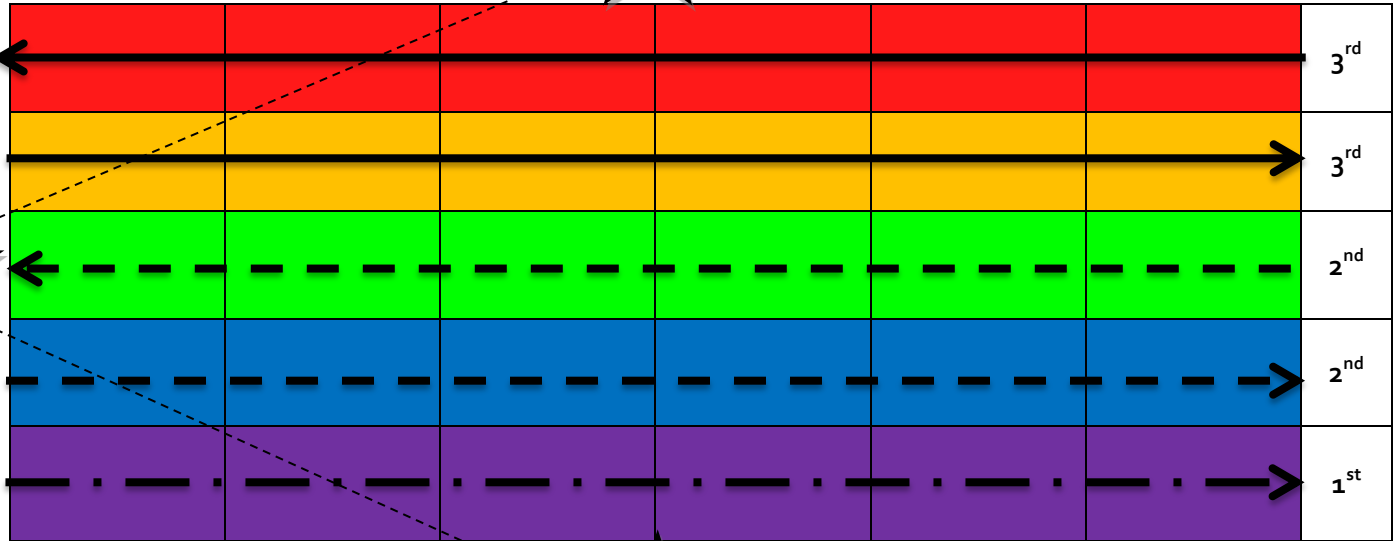

# School-wide: Lining Up from Desk to Door

Ownership, Accountability and Preparedness	
<p><b>Overseen by: Deans and Principal</b>  <b>Owner(s): Classroom Teachers, Interventionists, Learning Specialist</b></p> <p><b>Non-Negotiables:</b></p> <ul style="list-style-type: none"> <li>○ <b>No class shall enter the hallway unless they have 100% compliance in the classroom.</b></li> <li>○ All scholars must be assigned line spots.</li> <li>○ In order to maintain line order, transitions to the door must happen from the desks. (If scholars are at the carpet, transition back to desks and then transition to the door.)</li> <li>○ At the beginning of the year, tape line numbers inside squares so scholars know where to stand.</li> <li>○ Line order only changes to accommodate new scholars or proactive behavioral line changes)</li> <li>○ Transitions are 100% silent during every transition throughout the day               <ul style="list-style-type: none"> <li>○ Teacher(s) stand at designated position to lead transition (in front of the class, in front of rug, etc.)</li> <li>○ Teacher cuing is crisp with immediate scholar responses and 100% compliance.</li> <li>○ Precise student actions are scanned for and corrected with a quick do-it-better if expectations are not met.</li> <li>○ Designated pathways for each grade level are universal throughout each room, scholars travel along that pathway without confusion.</li> <li>○ Teacher uses non-verbals to transition their class, no words necessary to correct behavior.</li> <li>○ Silent. Scholars do not chant/cheer/count, all voices are silent.</li> <li>○ 30 seconds or less, using a timer and not teacher counting.</li> <li>○ Immediate. Transitions occur flawlessly between lessons and there is not a “lead up” or narration around the transition.</li> </ul> </li> <li>○ <b>Teacher Positioning:</b></li> <li>○ <b>With 2 Teachers:</b> Teacher I starts the transition at the front of the rug. Teacher II stands to meet the line and scan at the threshold of the door.</li> <li>○ <b>With 1 teacher:</b> Teacher transitions with the first row of scholars to the center of the room to observe the door and the rug. Once all scholars have lined up, move to the front of the line by the door.</li> </ul>	<p><b>Materials:</b></p> <ul style="list-style-type: none"> <li>○ Timer</li> <li>○ Tape for pathways</li> <li>○ Transition chart to record times earned</li> <li>○ REACH Bar</li> <li>○ Scholar Dollars</li> </ul>

**Procedure 1<sup>st</sup> Bellwether:** 8/19-9/4: Teacher directed with narration, mechanical student actions.

- K-1<sup>st</sup>: 3 minutes
- 2<sup>nd</sup>-4<sup>th</sup>: 2 minutes
- Teacher will teach scholars the 5 signaled steps to transitioning using the exact narration below, and do-it-better language.

Signal	Teacher Language	Teacher Action	Student Action
Before Transition	<b>"Backs tall, hands folded, eyes, tracking."</b>	Ensure 100% SLANT and tracking, positioned at the front of the room scanning.	100% in SLANT and tracking
Timer	Our goal is to transition in __ minutes.	Start timer.	Seated in SLANT.
Closed fist	<b>"Knees to window, ZERO"</b>	Lift arm from side in a fist, straight above head, scan for compliance	Scholars move their knees to right, in SLANT and tracking. Feet are flat on the ground.
One finger	<b>"Stand, ONE"</b>	Arm still above head, show one finger	Scholars stand, without taking any steps beside their chair.
Two fingers	<b>"Push in, hands on chair, TWO"</b>	Arm still above head, show two fingers	Scholars push in chair and stand behind with their hands on the backs of their chair.
Three fingers	<b>"Turn, THREE"</b>	Arm still above head, show three fingers	Scholars turn and face the right (see flow chart below)
*Snap*	<b>"Transition, *snap*"</b>	Teacher gives audible snap to begin transition standing in front of desks.	Scholars walk to the door in HALLS.
At door	Narrating for HALLS.	Scanning for hands, eyes, toes on line and silent.	Scholars silently walk with eyes forward, hands to sides, in a straight line.
Do it Better	Tell scholars: <ol style="list-style-type: none"> <li>1. Be seated or face forward in SLANT.</li> <li>2. State exactly what was wrong</li> <li>3. Tell/show the right way</li> <li>4. Immediately start signal to try again.</li> </ol> I.e.: "Scholars, be seated, I noticed some friends rotated in the incorrect direction. Point to where you see your rows arrow *snap* scholars point. Let's do it!" Show one. (And move through procedure accordingly.)		

**Procedure 2<sup>nd</sup> Bellwether: 9/7-9/18** Reduced teacher narration and non-verbals for the numbers, automatic student actions

- K-1<sup>st</sup>: 1.5 minutes
- 2<sup>nd</sup>-4<sup>th</sup>: 1 minute
- Teacher will teach scholars the 5 signaled steps to transitioning using the **minimal** narration below, and do-it-better language

Signal	Teacher Language	Teacher Action	Student Action
Before Transition	<b>"SLANT Check"</b>	Ensure 100% SLANT and tracking, positioned at the front of the room scanning.	100% in SLANT and tracking
Timer	Our goal is to transition in __ minutes.	Start timer.	Seated in SLANT.
Closed fist	Say <b>"knees"</b> , show fist.	Lift arm from side in a fist, straight above head, scan for compliance	Scholars move their knees to right, in SLANT and tracking. Feet are flat on the ground.
One finger	Say <b>"stand"</b> , show one finger	Arm still above head, show one finger	Scholars stand, without taking any steps beside their chair.
Two fingers	Say <b>"chair"</b> , show two fingers.	Arm still above head, show two fingers	Scholars push in chair and stand behind with their hands on the backs of their chair.
Three fingers	Say <b>"turn"</b> , show three fingers.	Arm still above head, show three fingers	Scholars turn and face the right (see flow chart below)
*Snap*	<b>"Transition, *snap*"</b>	Teacher gives audible snap to begin transition.	Scholars walk to the door in HALLS.
At door	Narrating for HALLS.	Scanning for hands, eyes, toes on line and silent.	Scholars silently walk with eyes forward, hands to sides, in a straight line.
Do It Better	Tell scholars: <ol style="list-style-type: none"> <li>1. Be seated or face forward in SLANT.</li> <li>2. State exactly what was wrong using economy of language.</li> <li>3. Tell/show the right way</li> <li>4. Immediately start signal to try again.</li> </ol> I.e.: "Be seated, I need all friends in HALLS. Let's do it!" Show one. (And move through procedure accordingly.)		

**Procedure 3<sup>rd</sup> Bellwether 9/21-10/2** Zero teacher narration, all non-verbals, internalized scholar habits

- Teacher will instruct scholars to follow the 5 signaled steps to transitioning from their desks to their rug seats, **non-verbally**. Scholar actions must be uniform and meet the non-negotiable criteria listed above.
  - Transition should take **30 seconds**.

Signal	Teacher Language	Teacher Action	Student Action
Before Transition	<b>"SLANT"</b>	Ensure 100% SLANT and tracking, positioned at the front of the room scanning.	100% in SLANT and tracking
Closed fist	None	Lift arm from side in a fist, straight above head.	Scholars move their knees to right, in SLANT and tracking.
One finger	None	Arm still above head, show one finger	Scholars stand, without taking any steps beside their chair.
Two fingers	None	Arm still above head, show two fingers	Scholars push in chair and stand behind with their hands on the backs of their chair.
Three fingers	None	Arm still above head, show three fingers	Scholars turn and face the right (see flow chart below)
*Snap*	None	Teacher gives audible snap to begin transition standing in front of desks.	Scholars walk to the door in HALLS.
At door	Non-verbal with thumbs up, all friends in HALLS, correct any non-verbally out of HALLS.	Scanning for hands, eyes, toes on line and silent.	Scholars silently walk with eyes forward, hands to sides, in a straight line.
Do It Better	Tell scholars: <ol style="list-style-type: none"> <li>1. Say, "Be seated"</li> <li>2. Stare at the scholar not in compliance, use proximity if necessary, move clip.</li> <li>3. Immediately start signal to try again. .</li> </ol> I.e.: "Be seated." While making strong eye contact in square up position with non-complier. Move their clip and non-verbal what they need to do. Whisper correct if necessary. Show one. (Move through procedure accordingly.)		

Diagram for Desk to Door:

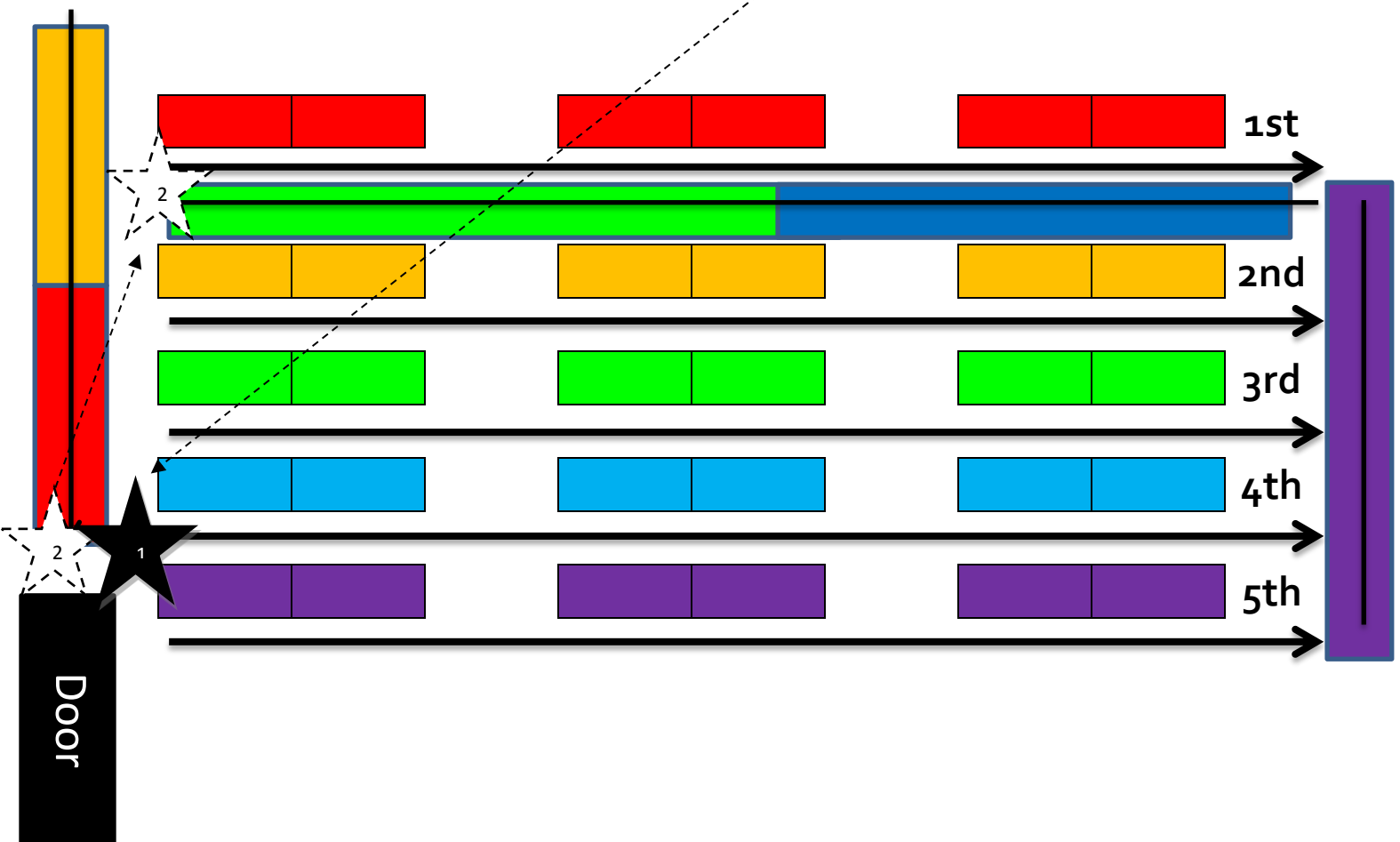
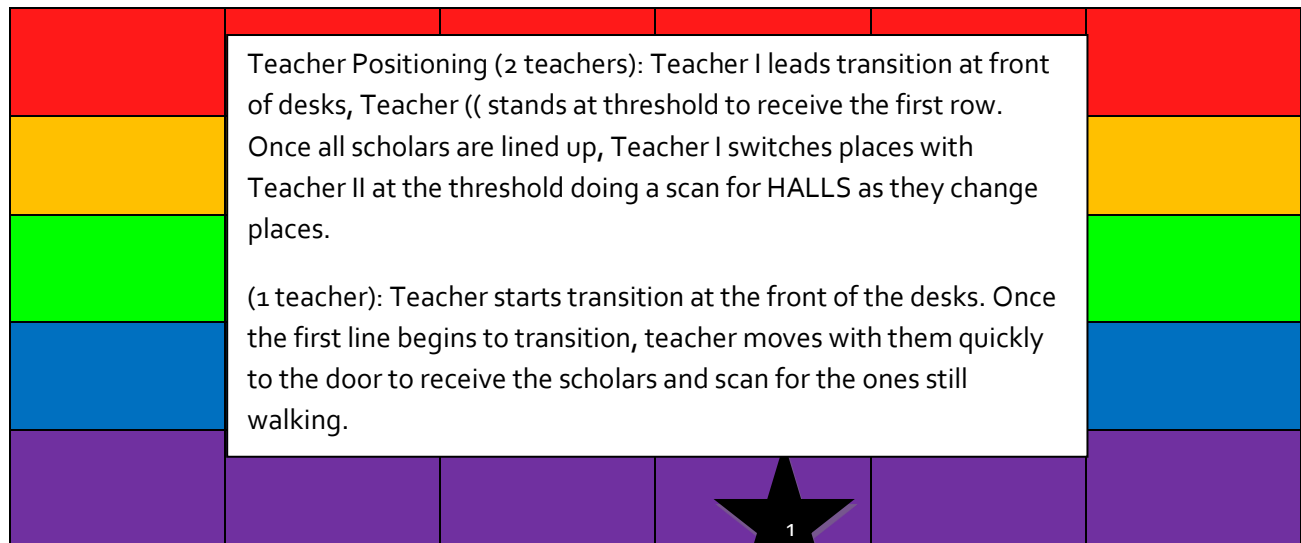

# School-wide: Hallway Transitions

Ownership, Accountability and Preparedness	
<p><b>Overseen by:</b> Deans and Principal</p> <p><b>Owner(s):</b> Classroom Teachers, Interventionists, Learning Specialist</p> <p><b>Non-Negotiables:</b></p> <ul style="list-style-type: none"><li>○ Transitions are silent as a sign of respect for others who are learning.</li><li>○ Our expectation is that scholars and teachers do not speak in the hall, and that teachers use a whisper only when absolutely necessary.</li><li>○ Teachers opt for non-verbals over speaking at all times.</li><li>○ Safety and appearance <b><u>before transitioning</u></b> will be emphasized with scholars: shoe laces tied, shirts tucked.</li><li>○ Safety while transitioning will be emphasized with no shoving to get in line, no pushing if someone is not walking fast enough etc.</li><li>○ Scholars stop at all stop signs in hallways.</li><li>○ Teachers inspect lines for 100% compliance for HALLS at every stop.</li><li>○ In the event of a whole group Do It Better, teacher will signal class to return to homeroom and re-direct inside of the classroom to maintain silence in the hall. This will be communicated with double clap and fingers in a whirling motion.</li><li>○ Scholars walk in a single file line, in a set line order that does not change.</li><li>○ Teacher I leads the class (walking backwards and facing the line) while Teacher II walks at the middle of the line overseeing the last half of the scholars.</li><li>○ The Teacher I carries the REACH bar.</li><li>○ Students <b><u>must never</u></b> transition the REACH bar</li><li>○ When we snap to get scholar's attention in the hallway, we snap at our arm by our side. Please don't snap in scholar's faces to get their attention. #rude</li></ul>	<p><b>Materials:</b></p> <ul style="list-style-type: none"><li>○ REACH Bar</li><li>○ Scholar Dollars</li></ul>

## Hallway Transitions Procedure:

Teachers I & II	Scholars
<ul style="list-style-type: none"> <li>○ Teachers <b>move</b> quickly, safely, silently through the hallways during transitions.</li> <li>○ Transitions in hallways occur in one line due to space constraints.</li> <li>○ Teacher I leads the class (walking backwards and facing the line) while Teacher II walks at the middle of the line overseeing the last half of the scholars.</li> <li> <ul style="list-style-type: none"> <li>○ <u>Non-Verbal Hallway Signals</u> <ul style="list-style-type: none"> <li>▪ Proceed/Continue: Two finger air traffic point</li> <li>▪ Stop: Five fingers up, pushing outward.</li> <li>▪ Hello: Finger wave, head nod, quick mini-wave.</li> <li>▪ Do It Better: Clap twice and twirl 2 fingers in a circular motion.</li> <li>▪ Too loud: Finger to mouth, no sound</li> <li>▪ Tuck in your shirt: Tucking in shirt motion</li> <li>▪ Tie your shoes: Point to shoes</li> </ul> </li> </ul> </li> <li>○ Hallway expectations are taught in the classroom, modeled for scholars walking on the lines of pathways inside of the class.</li> <li>○ Hallways remain silent of teacher and scholar voices to build the habit of silence, even when acclimating scholars to the HALLS procedure.</li> <li>○ Stating on day 1, if a whole group redirection is necessary, teachers bring scholars into the nearest classroom and use strong voice inside of the classroom to communicate the seriousness of the expectations for HALLS.</li> <li>○ If there is egregious or persistent misbehavior in the hallway it must be addressed immediately in the moment, but made as private and quiet as possible. In other words, this should not look like you yelling at scholar in the hallway. It should be, nonverbal “come with me”. Pull the scholar to the side and strongly whisper in their ear a clear what to do direction and that you will discuss how they will fix it when you get to the classroom.</li> <li>○ Redirections are done non-verbally. Only out of absolute necessity should a correction be <b>whispered</b> in the ear of the scholar.</li> </ul>	<ul style="list-style-type: none"> <li>○ Scholars walk in HALLS as per CP</li> <li>○ If there is an emergency, scholars show teachers the emergency non-verbal sign.</li> </ul>



## Criteria for Success of Transitions

<i>Teachers during a hallway transition:</i>	<i>Scholars in the hallway:</i>
<ul style="list-style-type: none"> <li>• Teacher I holds the REACH bar at the front of the line, facing scholars and walking backwards.</li> <li>• Teacher II is stationed midway to through the line scanning the last 15 on the line.</li> <li>• Are absolutely silent in the hallways</li> <li>• never have their back to the class</li> <li>• positioned so they can see all students on the line</li> <li>• use silent signals to correct behavior</li> <li>• If redirection is necessary, line stops and returns to the classroom.</li> </ul>	<ul style="list-style-type: none"> <li><input type="checkbox"/> are silent</li> <li><input type="checkbox"/> have eyes forward, never tracking to the side or behind</li> <li><input type="checkbox"/> have hands by their sides</li> <li><input type="checkbox"/> HALLS: H(ands by side), A(ll eyes forward), L(ips zipped), L(egs move safely), S (tick together).</li> <li><input type="checkbox"/> no gaps in the line</li> <li><input type="checkbox"/> in a super straight line</li> <li><input type="checkbox"/> have bodies off of the wall</li> <li><input type="checkbox"/> move with a sense of urgency</li> <li><input type="checkbox"/> lines stop at stop signs</li> <li><input type="checkbox"/> give a one finger wave to friends or staff</li> <li><input type="checkbox"/> do not get off of line to give hugs to adults</li> <li><input type="checkbox"/> the first person in line holds the door with their back, then goes to the end of the line</li> <li><input type="checkbox"/> door holder remains silent when classmates pass</li> <li><input type="checkbox"/> scholars passing say thank you non-verbally to the door holder</li> </ul>

## School-wide: 2<sup>nd</sup>-4<sup>th</sup> Independent Class Transitions

Ownership, Accountability and Preparedness	
<p>Overseen by: Deans and Principal Owner(s): Classroom Teachers, Interventionists, Learning Specialist</p> <p><b>Non-Negotiables:</b></p> <ul style="list-style-type: none"><li>○ <b>This transition is independent for scholars, so in the first 6 weeks of school scholar habits for HALLS must be met.</b></li><li>○ Transitions are silent as a sign of respect for others who are learning.</li><li>○ Our expectation is that scholars and teachers do not speak in the hall, and that teachers use a whisper only when absolutely necessary.</li><li>○ Teachers opt for non-verbals over speaking at all times.</li><li>○ Safety and appearance <b>before transitioning</b> will be emphasized with scholars: shoe laces tied, shirts tucked.</li><li>○ Safety while transitioning will be emphasized with no shoving to get in line, no pushing if someone is not walking fast enough etc.</li><li>○ Scholars stop at all stop signs in hallways.</li><li>○ Scholars walk in a single file line, in a set line order that does not change.</li><li>○ All teachers are “on” for the transition. Teacher I is stationed at the threshold facing the scholars walking towards them.</li><li>○ At least 3 teachers stand in the grey in the hallway and monitor independent transition.</li><li>○ Clip moves are captured by the three monitoring teachers and the threshold teacher.</li></ul>	<p><b>Materials:</b></p> <ul style="list-style-type: none"><li>○ REACH Bar</li></ul>

**Weeks 1-4 Independent Hallway Transitions Procedure:**

Teachers I & II	Scholars
<ul style="list-style-type: none"> <li>○ Scholars are led by <b>Teacher II</b>, who sees to it that each class reaches their destination.</li> <li>○ If there is a teacher that is solo without a co-teacher (science/social studies) those scholars are led by the classroom teacher until within eye shot of the receiving teacher.</li> <li>○ Then that teacher returns to retrieve their incoming class from the teacher who is waiting outside of the classroom supervising the scholars.</li> </ul>	<ul style="list-style-type: none"> <li>○ Scholars are led by Teacher II</li> <li>○ Scholars walk in HALLS</li> <li>○ Scholars walk in one line due to space constraints</li> <li>○ If there is an emergency, scholars show teachers the emergency non-verbal sign.</li> </ul>

**Weeks 4+ Independent Hallway Transitions Procedure:**

Teachers I & II	Scholars
<ul style="list-style-type: none"> <li>○ If there is a teacher that is solo without a co-teacher (science/social studies) those scholars are led by the classroom teacher until within eye shot of the receiving teacher.</li> <li>○ Then that teacher returns to retrieve their incoming class from the teacher who is waiting outside of the classroom supervising the scholars.</li> <li>○ All Teachers use the respective lining up procedure in class.</li> <li>○ 3 Teachers are stationed in the hall on the gray line before any scholars enter the hall.</li> <li>○ All classroom teachers peek their heads out of the door to ensure 100% of classes are ready to move.</li> <li>○ Teachers give a thumbs up outside of the door to signal this.</li> <li>○ Teachers in the classroom signal for the line leader to move to their respective destination. *The goal is for all children to be moving simultaneously to eliminate any down time or waiting in the hallway.</li> <li>○ Hallway transitions always occur in 1 line due to space restraints in the hallway.</li> <li>○ Hallway expectations are taught in the classroom, modeled for scholars walking on the lines of pathways inside of the class.</li> <li>○ Hallways remain silent of teacher and scholar voices to build the habit of silence, even when acclimating scholars to the HALLS procedure.</li> </ul>	<ul style="list-style-type: none"> <li>○ Scholars walk in HALLS</li> <li>○ Scholars walk in one line due to space constraints</li> <li>○ If there is an emergency, scholars show teachers the emergency non-verbal sign.</li> </ul>

- |  |  |
|--|--|
| <ul style="list-style-type: none"><li>○ If a whole group redirection is necessary, teachers bring scholars back to the classroom and use strong voice and proactive teacher moves inside of the classroom to communicate the seriousness of the expectations for HALLS.</li><li>○ If there is individual egregious or persistent misbehavior in the hallway it must be addressed immediately in the moment, but made as private and quiet as possible. Pull the scholar to the side and strongly whisper in their ear a clear what to do direction and that you will discuss how they will fix it when you get to the classroom.</li><li>○ The majority of redirections are done non-verbally. Only out of absolute necessity should a correction be <b>whispered</b> in the ear of the scholar.</li><li>○ Upon reaching their destination, scholars shake hands with their classroom teacher and commence Threshold greeting.</li></ul> |  |
|--|--|

### Criteria for Success of Independent Transitions

<i>Teachers during a hallway transition:</i>	<i>Scholars in the hallway:</i>
<ul style="list-style-type: none"> <li>• all 4 threshold teachers signal the beginning of the transition with a thumbs up</li> <li>• scholars are signaled to begin transition at the same time</li> <li>• At least 3 teachers present in the middle of the hallway scanning for safe transitions</li> <li>• are absolutely silent in the hallways</li> <li>• never have their back to the class</li> <li>• positioned so they can see all students on the line</li> <li>• use silent signals to correct behavior</li> <li>• If whole-group redirection is necessary, line stops and returns to the classroom to begin again from the starting point.</li> </ul>	<ul style="list-style-type: none"> <li><input type="checkbox"/> are silent</li> <li><input type="checkbox"/> have eyes forward, never tracking to the side or behind</li> <li><input type="checkbox"/> have hands by their sides</li> <li><input type="checkbox"/> HALL: H(ands by side), A(ll eyes forward), L(ips zipped), L(egs move safely).</li> <li><input type="checkbox"/> no gaps in the line</li> <li><input type="checkbox"/> in a super straight line</li> <li><input type="checkbox"/> have bodies off of the wall</li> <li><input type="checkbox"/> move with a sense of urgency</li> <li><input type="checkbox"/> lines stop at stop signs</li> <li><input type="checkbox"/> give a one finger wave to friends or staff</li> <li><input type="checkbox"/> do not get off of line to give hugs to adults</li> </ul>

### School-wide: Stairwell Transitions

Ownership, Accountability and Preparedness	
<p><b>Overseen by:</b> Deans and Principal</p> <p><b>Owner(s):</b> Classroom Teachers, Interventionists, Learning Specialist</p> <p><b>Non-Negotiables:</b></p> <ul style="list-style-type: none"> <li>○ Transitions are silent as a sign of respect for others who are learning.</li> <li>○ Our expectation is that scholars and teachers do not speak in the hall, and that teachers use a whisper <b>only</b> when absolutely necessary.</li> <li>○ Teachers opt for non-verbals over speaking at all times.</li> <li>○ Safety and appearance <b>before transitioning</b> will be emphasized with scholars: shoe laces tied, shirts tucked.</li> <li>○ Safety while transitioning will be emphasized with no shoving to get in line, no pushing if someone is not walking fast enough etc.</li> <li>○ Scholars stop at all stop signs in stairs.</li> <li>○ Teachers inspect lines for 100% compliance for HALLS at every stop, not going more than one landing without expecting.</li> <li>○ In the event of a whole group do-it-better, teacher will signal class to return to the classroom to maintain silence in the hall.</li> <li>○ Scholars walk in double file lines, in a set line order that does not change.</li> <li>○ Teacher I leads the two lines from the front (walking backwards and facing the line) and Teacher II walks at the end of the line walking in between lines to observe compliance.</li> <li>○ Teacher I carries the REACH bar.</li> </ul>	<p><b>Materials:</b></p> <ul style="list-style-type: none"> <li>○ REACH Bar</li> <li>○ Scholar Dollars</li> </ul>

### Stairwell Transitions Procedure:

Teachers I & II	Scholars
<ul style="list-style-type: none"> <li>● Teacher I holds the REACH bar at the front of the line, facing scholars and walking backwards.</li> <li>● Teacher II is stationed at the rear of the line, frequently walking through the middle to check compliance.</li> <li>● Teachers are absolutely silent in the hallways</li> <li>● Teachers never have their back to the class</li> <li>● Teachers are positioned so they can see all students on the line</li> <li>● Teachers use silent signals to correct behavior</li> <li>● If redirection is necessary, line stops and returns to the classroom.               <ul style="list-style-type: none"> <li>▪ <u>Non-Verbal Hallway Signals</u> <ul style="list-style-type: none"> <li>▪ Proceed/Continue : Two finger air traffic point</li> <li>▪ Stop: Five fingers up, pushing outward.</li> <li>▪ Hello: Finger wave, head nod, quick mini-wave.</li> <li>▪ Do it again: Clap twice and twirl 2 fingers in a circular motion.</li> <li>▪ Too loud: Finger to mouth, no sound</li> <li>▪ Tuck in your shirt: Tucking in shirt motion</li> <li>▪ Tie your shoes: Point to shoes</li> </ul> </li> </ul> </li> </ul>	<ul style="list-style-type: none"> <li>○ Scholars walk in HALLS</li> <li>○ Scholars and adults <b>move</b> quickly, safely, silently through the hallways during transitions.</li> <li>○ Stairwell transitions always occur in 2 lines. The first 15 scholars walk to the left and stop at the first stop sign. The second line of 15 scholars waterfall behind the first line to the right and stop at the first stop sign.</li> <li>○ Line leaders stop at every stop sign so that teachers can scan and check for 100% compliance in HALLS.</li> <li>○ First scholar in line must hold door open for class. They stand silently, with back to the door, keeping it open for the class to pass.</li> <li>○ After class passes, door holder must then join the back of the line.               <ul style="list-style-type: none"> <li>○ If first scholar in line is there for behavior, have the 2<sup>nd</sup> scholar in line hold the door</li> </ul> </li> <li>○ Jackets should be folded over arm and held at chest.</li> <li>○ If there is an emergency, scholars show teachers the emergency non-verbal sign.</li> </ul>

<i>Teachers during a stair transition:</i>	<i>Scholars walk on the stairs with:</i>
<ul style="list-style-type: none"> <li>• 1st teacher holds the REACH bar at the front of the line, facing scholars and walking backwards.</li> <li>• 2nd teacher is stationed at the rear of the line, frequently walking through the middle to check compliance.</li> <li>• Are absolutely silent in the hallways</li> <li>• never have their back to the class</li> <li>• positioned so they can see all students on the line</li> <li>• use silent signals to correct behavior</li> <li>• If redirection is necessary, line stops and returns to the classroom.</li> </ul>	<ul style="list-style-type: none"> <li><input type="checkbox"/> are silent</li> <li><input type="checkbox"/> have eyes forward, never tracking to the side or behind</li> <li><input type="checkbox"/> have hands by their sides</li> <li><input type="checkbox"/> HALLS: H(ands by side), A(All eyes forward), L(ips zipped), L(egs move safely), S(tick together).</li> <li><input type="checkbox"/> no gaps in the line</li> <li><input type="checkbox"/> in a super straight line</li> <li><input type="checkbox"/> have bodies off of the wall</li> <li><input type="checkbox"/> move with a sense of urgency</li> <li><input type="checkbox"/> lines stop at stop signs</li> <li><input type="checkbox"/> give a one finger wave to friends or staff</li> <li><input type="checkbox"/> do not get off of line to give hugs to adults</li> <li><input type="checkbox"/> the first person in line holds the door with their back, then goes to the end of the line</li> <li><input type="checkbox"/> door holder remains silent when classmates pass</li> <li><input type="checkbox"/> scholars passing say thank you non-verbally to the door holder</li> </ul>

## School-wide: Entrance from Hall to Desks or to Rugs

Ownership, Accountability and Preparedness	
<p><b>Overseen by:</b> Deans and Principal</p> <p><b>Owner(s):</b> Classroom Teachers, Interventionists, Learning Specialist</p> <p><b>Non-Negotiables:</b></p> <ul style="list-style-type: none"> <li>○ Scholars enter their classroom from the hall and walk directly to their desks in their specified line order.</li> <li>○ There should be no walking behind or through scholar desks creating potential opportunistic behaviors, like hitting, tripping, or running.</li> <li>○ Scholars take designated pathways to their desks.</li> </ul>	<p><b>Materials:</b></p> <ul style="list-style-type: none"> <li>○ REACH Bar</li> <li>○ Seating chart</li> <li>○ Scholar Dollars</li> </ul>

### Entrance from Hall to Desks or Rug Procedure



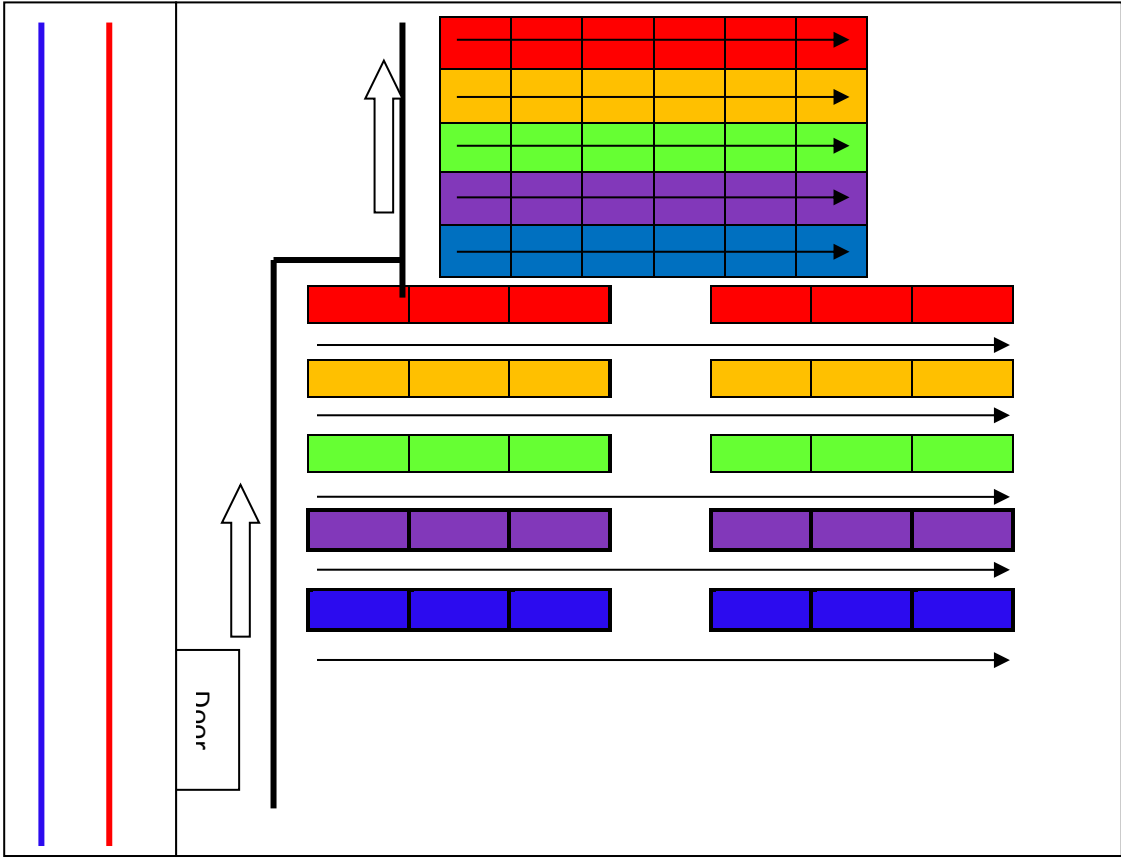

Teachers I&II	Scholars
<ul style="list-style-type: none"> <li>• <b>Teachers</b> monitor student transition and narrate students who've followed Precise Directions provided.</li> </ul>	<ul style="list-style-type: none"> <li>○ From the hallway, scholars are already in their line order to take their seats in a uniform and efficient manner.</li> <li>○ <b>To Desks:</b> Scholars enter the classroom and walk directly to their seat using the designated pathway and sit in SLANT or begin Bright Work. <ul style="list-style-type: none"> <li>○ In the event that scholars are out of line order when they enter the classroom, scholars should carefully walk along their designated pathway to their desk seat without touching any other scholar on the way.</li> </ul> </li> <li>○ <b>To Rug:</b> Scholars enter the classroom and walk directly to their seat using the designated pathway and immediately sit down in the center of their square. <ul style="list-style-type: none"> <li>○ In the event that scholars are out of line order when they enter the classroom, scholars should be directed to stand in the middle of their rug seats until all scholars have made it to the center of their square, they will then be instructed to have a seat.</li> </ul> </li> </ul>





# School-wide: Hand Signals and Emergencies

Ownership, Accountability and Preparedness	
<p><b>Overseen by:</b> Leadership Team  <b>Owner(s):</b> All teachers</p> <p><b>Non-Negotiables:</b></p> <ul style="list-style-type: none"> <li>○ Hand signals should be used in class in order for teachers to determine the needs of scholars.</li> <li>○ If a hand is raised and the teacher tells a scholar to put it down, there must be a follow-up to see why the scholar's hand was raised.</li> <li>○ We differentiate with various hand signals so that we know the urgency in which to attend to scholar needs (i.e.: bathroom emergency v. question)</li> <li>○ A vertical hand should be reinforced for all scholars utilizing hand signals.</li> <li>○ All hand signals are to be used silently.</li> </ul>	<p><b>Materials:</b></p> <ul style="list-style-type: none"> <li>○ Visual Anchors</li> </ul>

Signal	Meaning for Scholars	Visual
Raised Hand	Used if you have a question or want to answer a question.	 <p>(straight arm, five fingers)</p>
Bathroom	Used if you need to use the washroom	 <p>(four fingers)</p>
Water	Used if you are thirsty and need water (lunch, bathroom break are best times for water)	 <p>(three fingers)</p>
Tissue	Use if nose is running and you need a tissue	 <p>(two fingers)</p>

<p>Pencil</p>	<p>Use if your pencil is broken or you don't have a pencil</p>	 <p>(one finger)</p>
<p>Emergency</p>	<p>Use if you have an emergency like someone has hurt you, or you have had an accident.</p>	<p>(make an x with arms)</p>

# School-wide: Time Out

Ownership, Accountability and Preparedness	
<p><b>Overseen by: Classroom Teachers</b>  <b>Owner(s): LT</b></p> <p><b>Non-Negotiables:</b></p> <ul style="list-style-type: none"> <li>• Time out is the designated area for scholars to take a step away from the team to think about how they plan to fix it before returning to the team, and should be framed in that way.</li> <li>• Weeks 1 – 3:               <ul style="list-style-type: none"> <li>○ Time outs should be FULLY facilitated by Teacher.</li> </ul> </li> <li>• Weeks 4 -6:               <ul style="list-style-type: none"> <li>○ Time outs should be PARTIALLY facilitated by Teacher II</li> </ul> </li> <li>• Weeks 6+:               <ul style="list-style-type: none"> <li>○ Time outs should be PARTIALLY facilitated by Teacher.</li> <li>○ Teacher II sets timer for 2 minutes ONLY when scholar sits with feet flat, eyes forward, and has hands in SLANT.</li> <li>○ If at any point during time out, scholar is not sitting correctly, Teacher II pauses the timer. Teacher II resumes the timer when scholar has fixed it. The timer should NOT start again.</li> <li>○ When timer beeps, Teacher II quickly addresses behavior by saying, "You were doing X". When you go back, don't forget to do Y. I know you can do it. Let's go."</li> <li>○ The teacher will silently walk scholar back to the group and ensure that he/she sits correctly.</li> <li>○ Teacher I welcomes back with silent regard (nod, smile, or thumbs up.)</li> <li>○ Teacher I affirms scholar coming back and fixing it within 2m of returning to group.</li> </ul> </li> <li>• Weeks 4 -6:               <ul style="list-style-type: none"> <li>○ Time outs should be PARTIALLY facilitated by Teacher II.</li> <li>○ Teacher II follows scholar to time out and ensures correct posture before setting a 2-minute timer.</li> <li>○ Teacher II turns away from scholar to monitor the body of the class, only turning around to check for compliance every few seconds.</li> <li>○ If at any point during time out, scholar is not sitting correctly, Teacher II pauses the timer. Teacher II resumes the timer when scholar has fixed it. The timer should NOT start again.</li> <li>○ When timer beeps, Teacher quickly addresses behavior by saying, "You were doing X". When you go back, don't forget to do Y. I know you can do it. Let's go."</li> <li>○ The scholar will walk back to their seat independently. Teacher II will scan this transition and intervene</li> </ul> </li> </ul>	<p><b>Materials:</b></p> <ul style="list-style-type: none"> <li>○ Designated timeout space (desk and chair)</li> <li>○ Digital magnetic timer (manipulated by Teacher ONLY)</li> <li>○ Restorative Conversation VA</li> </ul>

immediately if the scholar does not transition correctly.

- Weeks 7 – EOY:
  - Time outs should be PARTIALLY facilitated by Teacher.
  - Scholar moves to the timeout space independently.
  - Teacher starts timer from a distance, if necessary, when scholar is sitting appropriately.
  - By this point, scholars *should* be starting the timer themselves and sitting in SLANT independently for their 2m.
  - Teacher pauses timer if scholar is not sitting correctly.
  - When timer beeps, Teacher quickly addresses behavior by saying, "You were doing X". When you go back, don't forget to do Y. I know you can do it. Let's go."
  - The scholar returns to the team.
  
- Potential Pitfalls:
  - Timeout is not a revolving door. The reason for timeout is to end the behavior and must be effective.
  - This is a moment for scholars to stop their behavior in a calm way. Therefore, teacher tone and demeanor around the word "timeout" should set scholars up for successful repair.
  - Refusing to go to timeout is automatic Orange. (The "Reparative Conversation" is specified below.)
  - Just because a child has to go to timeout does not mean a scholar is on Orange. It is one clip move.
  - A scholar that is in timeout must be on yellow or below because teacher needs to give at least 2 corrections before moving a scholar to time-out.
  - If scholar comes out of SLANT and is obviously not following directions throughout the timeout, the timer is paused and then restarting from where you paused.
  - If you feel the child is not ready, use a teacher move.
  - More than one child in timeout?
    - The child in timeout is ready - "Work the Clock"
    - The child in timeout is not ready – Co-teacher is called to address the scholar in timeout off-stage and sends the other scholar to timeout. THIS SHOULD NOT HAVE TO HAPPEN☺
  - Unsuccessful timeouts?
    - Call for push-in
    - Use teacher moves

## Time Out Procedure

Teachers I&II	Scholars
<ul style="list-style-type: none"> <li>• Within one lesson               <ul style="list-style-type: none"> <li>○ Upon the 1st reminder, Teacher redirects scholar and make the appropriate REACH bar tracker adjustment</li> <li>○ Upon the 2nd reminder, Teacher tracks their choice and uses a logical consequence in the moment.</li> <li>○ Upon the 3rd reminder within the same lesson, Scholar is sent to timeout for only 2 minutes, using the weekly breakdown below</li> </ul> </li>   <li>• Weeks 1 – 3:               <ul style="list-style-type: none"> <li>○ Time outs should be FULLY facilitated by Teacher.</li> <li>○ Teacher sets timer for 2 minutes ONLY when scholar sits with feet flat, eyes forward, and has hands in SLANT.</li> <li>○ If at any point during time out, scholar is not sitting correctly, teacher pauses the timer. Teacher resumes the timer when scholar has fixed it. The timer should NOT start again.</li> <li>○ When timer beeps, Teacher quickly addresses behavior by saying, "You were doing X". When you go back, don't forget to do Y. I know you can do it. Let's go."</li> <li>○ The teacher silently walks scholar back to the group and ensure that he/she sits correctly.</li> <li>○ Teacher welcomes back with silent regard (nod, smile, or thumbs up.)</li> <li>○ Teacher affirms scholar coming back and fixing it within 2m of returning to group.</li> </ul> </li>   <li>• Weeks 4 -6:               <ul style="list-style-type: none"> <li>○ Time outs should be PARTIALLY facilitated by Teacher II</li> <li>○ Teacher follows scholar to time out and ensures correct posture before setting a 2-minute timer.</li> <li>○ Teacher turns away from scholar to monitor the body of the class, only turning around to check for compliance every few seconds.</li> <li>○ If at any point during time out, scholar is not sitting correctly, teacher pauses the timer. Teacher resumes the timer when scholar has fixed it. The timer should NOT start again.</li> <li>○ When timer beeps, Teacher quickly addresses behavior by saying, "You were doing X". When you go back, don't forget to do Y. I know you can do it. Let's go."</li> <li>○ The scholar will walk back to their seat independently. The co-teacher will scan this transition and intervene immediately if the scholar does not transition correctly.</li> </ul> </li>   <li>• Weeks 6+:</li> </ul>	<ul style="list-style-type: none"> <li>• Scholars' appropriate response               <ul style="list-style-type: none"> <li>○ Weeks 1 – 6:                   <ul style="list-style-type: none"> <li>▪ Teacher says, "Time out". (Teacher follows through.)</li> <li>▪ Scholars responds, "Yes Mr./Ms. _____" OR "Got it"</li> </ul> </li>   <li>○ Weeks 6+:                   <ul style="list-style-type: none"> <li>▪ Teacher nonverbally signals to the timeout space.</li> <li>▪ Scholar silently moves to timeout space.</li> </ul> </li> </ul> </li>   <li>• Scholar sits with feet flat, eyes forward, and has hands in SLANT.</li> </ul>

- |  |  |
|--|--|
| <ul style="list-style-type: none"><li>○ Time outs should be PARTIALLY facilitated by Teacher.</li><li>○ Scholar moves to the timeout space independently.</li><li>○ Teacher starts timer from a distance, if necessary, when scholar is sitting appropriately.</li><li>○ By this point, scholars <i>should</i> be starting the timer themselves and sitting in SLANT independently for their 2m.</li><li>○ Teacher pauses timer if scholar is not sitting correctly.</li><li>○ When timer beeps, Teacher quickly addresses behavior by saying, "You were doing X". When you go back, don't forget to do Y. I know you can do it. Let's go."</li><li>○ The scholar returns to the team.</li></ul> |  |
|--|--|

- Egregious disrespect response (Orange): Reparative Conversation

**Structure of the Reparative Conversation (ReCon): Remember, this is after disrespect or behavior that takes away learning from others. The purpose of the ReCon is to have scholar rebuild relationship with teacher through 1:1 Conversation and reflect on choices they made so they are not repeated.**

- Allow scholar to save face. Find the most private place possible in the room.
  - **Give clear direction for tracking, posture at eye level to scholar, neutral tone.**
  - **Teacher uses empathy or relationship building line**
    - Good morning/afternoon. How are you today?
    - I noticed...
    - It looks like you're really bummed out right now; I want to help you get back on track. Let's talk so that we can fix it together.
  - **Brings light to the specific behavior to probe**
    - While the entire class was completing their work, I asked you to pick up your pencil and begin work. What choice did you make at that moment in class?
  - **Connect the choice to the scholar's academics, to them personally, to their family, to their peers, or their community. Pick the connection that is most impactful to the scholar.**
    - How is that choice detrimental to you?
    - Is this choice helping or hindering you from making strong grades?
    - Was this a positive or negative choice? Why?
    - Why is that important?
  - **Identify how to fix it now and next time.**
    - What can you do differently next time you...?
    - What do you need to do right now when you return to your seat?
    - Why should you do this differently?
    - How do you think you should make this up to your peers that you disrupted?
  - **Teacher affirms scholar's cooperation and ends with warm-demanding expectation of scholar.**
    - The entire conversation you were reflective, honest, and respectful despite feeling upset. I appreciate you showing this level of maturity and trusting me to hear you out so that we can fix it together. It is not acceptable to opt out of work or meeting expectations because it means (academic/career/personal connection) but I know you are ready to bounce back and are more than capable of meeting expectations, working hard, and gaining the knowledge you need for (insert academic/career/personal connection). Let's get back to work, I know you can do it.



## Miscellaneous Strategies to Calming and Addressing Behaviors

<b>Strategies to Calm behaviors</b>
<ul style="list-style-type: none"> <li>❑ <b>Giving the scholar a break</b> (change to go to bathroom, get water, etc.)</li> <li>❑ <b>Divert the scholar's attention</b> (by giving a job, giving them independent work)</li> <li>❑ <b>Allow choice</b> ("You may stay on the carpet or read a book at your desk)</li> <li>❑ <b>Distraction</b> (give the scholar a job/task to do)</li> <li>❑ <b>Use of nonverbal reminders</b></li> <li>❑ <b>Give independent work</b> for the scholar to do (even if during a mini-lesson)</li> <li>❑ <b>Whole Class Reminder</b></li> <li>❑ <b>Changing the scholar's seat/place in line</b></li> <li>❑ <b>Gentle touch</b></li> </ul> <p style="margin-left: 20px;"><b>Ignoring the behavior</b></p>

<b>Possible Language/ Logical Consequences to Keep Learning the Focus</b>	
<ul style="list-style-type: none"> <li>❖ Staring or rolling eyes, sucking teeth, head down</li> <li>❖ Super-slow walking</li> <li>❖ Complying in a mocking way</li> <li>❖ Refusal to follow instructions or work (defiance, not incompetence.)</li> <li>❖ Lying about something minor (e.g. I didn't take her pencil, when you clearly saw it)</li> <li>❖ Talking back to teacher under their breath</li> <li>❖ Going mute when scholar is upset, refusing to engage with teacher intentionally.</li> </ul>	<ul style="list-style-type: none"> <li>➤ "That is an unacceptable response. I understand that you're upset. But, we can talk about it later. Okay?"</li> <li>➤ Tap scholar on the back, in the direction they should be walking, saying "We're going this way to _____. You can come with us or be left behind to complete _____ later OR You can come with us or completely miss out on the next activity even if you decide to show up later."</li> <li>➤ "I see that you're having trouble doing this the kind way. So, we'll practice later." (Then, ignore.)</li> <li>➤ "We're going on to _____. Before you leave today, you will _____."</li> <li>➤ "Lying about is not the way to go. Trust is hard to earn. It's hard to take your side and protect you if you're not honest with me. Next time, own it, and let me know exactly what happened so we can work it out together."</li> <li>➤ "That is an unacceptable response. I understand that you're upset. But, instead of whispering under your breath, let's talk about it later. Okay?"</li> <li>➤ "That is an unacceptable response. I understand that you're upset. Would you like to talk about it now or just fix it? Okay... If you can't fix it on your own, we're going to take time during _____ to fix it together, got it?"</li> </ul>

## School-wide Routine: Social Opportunities – REACHess

Ownership, Accountability and Preparedness	
<p><b>Overseen by:</b> Deans and Principal</p> <p><b>Owner(s):</b> Homeroom Teachers, TIRs</p> <p><b>Non-Negotiables:</b></p> <ul style="list-style-type: none"> <li>• Scholars with incomplete HW complete HW during this time.</li> <li>• K/1: 7 staff members on for REACHess, each with an assigned repeatedly do</li> <li>• 2-4: 6 staff members on for REACHess, each with an assigned repeatedly do</li> <li>• Yellow/Gray Scholars sit on the ledge, waiting for their Play Time</li> <li>• REACHess teachers should be fully ON:               <ul style="list-style-type: none"> <li>○ <b>No cell phone use at this time.</b></li> <li>○ <b>All teachers on the field, not the sidelines (black) or sitting</b></li> <li>○ <b>All teachers spread out with a broad view of all that is happening.</b></li> </ul> </li> <li>• REACHess teacher should use sitting out briefly as a logical consequences for not following these rules and expectations every day:               <ul style="list-style-type: none"> <li>○ Hands and body to self.</li> <li>○ Be safe and kind.</li> </ul> </li> <li>• If you hear the call to attention, freeze, take a knee, and track the teacher.</li> <li>• REACHess yard will be divided into four sections, using cones.</li> <li>• <b>Red/Orange</b> are called to line up in the classroom first.</li> <li>• Then, scholar names are called from the top of the REACH bar. So, they are in order for play time and separated for reset.</li> <li>• Each class has recess together with their teachers, but of course, can choose the specific REACHess center they play in.</li> <li>• Teachers bring your class order, to ensure that scholars are lined up in the proper order upon REACHess dismissal.</li> <li>• In K-1, there will be 7 staff members on REACHess               <ul style="list-style-type: none"> <li>○ 1 person supervises each class (3) and has a system for inputting REACH colors</li> <li>○ 1 person to supervise scholars on Orange/Red (Takes them inside for Reflection)</li> <li>○ 2 people to supervise Yellow/Gay</li> <li>○ 1 Yellow/Gray (This person starts with Yellow/Gray and then supervises scholars who are going to washroom.)</li> <li>○ 1 person doing HW redo inside one classroom</li> </ul> </li> <li>• In 2<sup>nd</sup>-4<sup>th</sup> grade, there will be 6 staff members on REACHess               <ul style="list-style-type: none"> <li>○ 1 person to supervise scholars on Orange/Red (Takes them inside for Reflection)</li> <li>○ 1 person doing HW redo inside the nearest classroom.</li> </ul> </li> <li>• Orange/Red goes to nearest classroom (3 &amp;4) or hallway to complete</li> </ul>	<p><b>Materials:</b></p> <ul style="list-style-type: none"> <li>○ REACH Bar</li> <li>○ REACHess Station materials</li> <li>○ Scholar Dollars</li> </ul>

Orange Reflection.

- Scholars have a clear entrance routine and assigned place to go when they come onto the field.

**Procedure:**

When REACHess is BEFORE lunch	Teachers	Scholars
<ul style="list-style-type: none"> <li>• <b>*3 or 4 Teachers:</b> Monitoring each homeroom as they play.</li> <li>• <b>1 Teacher:</b> Monitoring Gray</li> <li>• <b>1 Teacher:</b> Monitoring Yellow. Once yellow can play, this teacher goes inside to monitor washrooms.</li> <li>• <b>1 TIR:</b> Monitoring HW redo (For this to work, TIR must do HW redo in last classroom of the hallway. Teachers drop off homework scholars as they walk to yard. Indoor REACHess? HW done in homeroom with teachers</li> <li>• <b>1 Teacher (GLL):</b> Monitoring Orange/Red Reflection. (For this to work, Teacher must pull all Orange/Red scholars before classes exit for REACHess</li> </ul> <p>*One of these teachers is responsible for yard set up before scholars come outside:</p> <ul style="list-style-type: none"> <li>• Yard sectioned off into 4 stations using cones</li> <li>• REACHess games materials in the</li> </ul>	<ul style="list-style-type: none"> <li>○ <b>During REACHess</b> <ul style="list-style-type: none"> <li>○ Stairs are completely silent as scholars approach the outdoor space in their line order.</li> <li>○ Scholars enter the space in a straight line.</li> <li>○ Teacher I leads front of line into play time and dismisses Yellow/Gray to the ledge.</li> <li>○ Teacher I then dismisses students to choose one of four stations to play in.</li> <li>○ Scholars engage in free play with MAXIMUM SUPERVISION. Be vigilant to ensure</li> </ul> </li> <li>○ <b>REACHess Exit</b> <ul style="list-style-type: none"> <li>○ Teacher blows whistle once. Scholars freeze and take a knee.</li> <li>○ At this time, Orange/Red scholars come back outside to join line up routine.</li> <li>○ K-1 scholars are called by row line up in front of their teacher. (Ex: If you sit in RED row, line up. If you sit in row THREE, line up) 2-4 scholars</li> </ul> </li> </ul>	<ul style="list-style-type: none"> <li>○ <b>During REACHess</b> <ul style="list-style-type: none"> <li>○ Stairs are completely silent as scholars approach the outdoor space in their line order.</li> <li>○ Scholars enter the space in a straight line.</li> <li>○ Teacher I leads front of line into play time and dismisses Yellow/Gray or Orange/Red to their respective areas. Remember, Orange/Red will be going into the building with one teacher.</li> <li>○ Scholars engage in free play with MAXIMUM SUPERVISION. Be vigilant to ensure</li> </ul> </li> <li>○ <b>REACHess Exit</b> <ul style="list-style-type: none"> <li>○ Teacher blows whistle once. Scholars freeze and take a knee.</li> <li>○ At this time, Orange/Red scholars come back outside to join line up routine.</li> <li>○ K-1 scholars are called by row line up in front of their teacher. (Ex: If you sit in RED row, line up. If</li> </ul> </li> </ul>

center of each station	<p>line up with their <i>next</i> subject teacher, in the order they leave the field. The classroom whose destination is furthest will always leave the field first.</p> <ul style="list-style-type: none"> <li>○ Classes stand in line and, at teacher's instruction, begin walking toward their next class.</li> </ul>	<p>you sit in row THREE, line up) 2-4 scholars line up with their <i>next</i> subject teacher, in the order they leave the field. The classroom whose destination is furthest will always leave the field first.</p> <ul style="list-style-type: none"> <li>○ Classes stand in line and, at teacher's instruction, begin walking toward their next class.</li> </ul>
------------------------	--	--

When REACHess is AFTER lunch	Teachers	Scholars
<ul style="list-style-type: none"> <li>• <b>*3 or 4 Teachers:</b> Monitoring each homeroom as they play.</li> <li>• <b>1 Teacher:</b> Monitoring Gray</li> <li>• <b>1 Teacher:</b> Monitoring Yellow. Once yellow can play, this teacher goes inside to monitor washrooms.</li> <li>• <b>1 TIR:</b> Monitoring HW redo (For this to work, TIR must retrieve HW scholars as they exit the cafeteria on their way outside.</li> <li>• <b>1 Teacher (GLL):</b> Monitoring Orange/Red Reflection. (For this to work, Teacher pulls scholars at Threshold to REACHess yard.</li> </ul> <p>*One of these teachers is responsible for yard set up</p>	<ul style="list-style-type: none"> <li>○ <b>During REACHess</b> <ul style="list-style-type: none"> <li>○ Stairs are completely silent as scholars approach the outdoor space in their line order.</li> <li>○ Scholars enter the space in a straight line.</li> <li>○ Teacher I leads front of line into play time and dismisses Yellow/Gray to the ledge, Orange/Red with teacher.</li> <li>○ Teacher I then dismisses students to choose one of four stations to play in.</li> <li>○ Scholars engage in free play with MAXIMUM SUPERVISION. Be vigilant to ensure</li> </ul> </li> <li>○ <b>REACHess Exit</b> <ul style="list-style-type: none"> <li>○ Teacher blows whistle once.</li> </ul> </li> </ul>	<ul style="list-style-type: none"> <li>○ <b>During REACHess</b> <ul style="list-style-type: none"> <li>○ Stairs are completely silent as scholars approach the outdoor space in their line order.</li> <li>○ Scholars enter the space in a straight line.</li> <li>○ Teacher I leads front of line into play time and dismisses Yellow/Gray to the ledge</li> <li>○ Scholars engage in free play with MAXIMUM SUPERVISION. Be vigilant to ensure</li> </ul> </li> <li>○ <b>REACHess Exit</b> <ul style="list-style-type: none"> <li>○ Teacher blows whistle once. Scholars freeze and take a knee.</li> <li>○ At this time, Orange/Red scholars come back outside to</li> </ul> </li> </ul>

<p>before scholars come outside:</p> <ul style="list-style-type: none"> <li>• Yard sectioned off into 4 stations using cones</li> <li>• REACHess games materials in the center of each station</li> </ul>	<p>Scholars freeze and take a knee.</p> <ul style="list-style-type: none"> <li>○ At this time, Orange/Red scholars come back outside to join line up routine.</li> <li>○ K-1 scholars are called by row line up in front of their teacher. (Ex: If you sit in RED row, line up. If you sit in row THREE, line up) 2-4 scholars line up with their <i>next</i> subject teacher, in the order they leave the field. The classroom whose destination is furthest will always leave the field first.</li> <li>○ Classes stand in line and, at teacher's instruction, begin walking toward their next class.</li> </ul>	<p>join line up routine.</p> <ul style="list-style-type: none"> <li>○ K-1 scholars are called by row line up in front of their teacher. (Ex: If you sit in RED row, line up. If you sit in row THREE, line up) 2-4 scholars line up with their <i>next</i> subject teacher, in the order they leave the field. The classroom whose destination is furthest will always leave the field first.</li> <li>○ Classes stand in line and, at teacher's instruction, begin walking toward their next class.</li> </ul>
---	--	---

### Orange/Red Reflection

- Scholars will complete an Orange/Red reflection sheet during REACHess when on Orange or Red.
- This page provides them space to reflect on the choices they made, how they impacted others, and what they must do differently next time.
- This reflection must also be sent home by EOD.
- Teacher monitoring Orange/Red scholars is responsible for having Orange/Red Reflection Basket Prepared
  - Includes Pencils
  - Folder full of Orange reflections
- Teacher will accept all Orange/Red scholars as they walk past threshold for REACHess yard.
- Expectations: Sounds off, complete sentences, best handwriting.
- Expectations not met: They must redo the reflection during Coop Play

**Inclement Weather Expectations** –Students having free structured play time gives them time to build relationships amongst peers and interact in a non-academic, kid friendly way. However, there are times when, due to weather, we must have REACHess inside. To that end, **GLL will have final say as to if grade has REACHess**. GLL will use this guidance and have grade stay inside if:

- < 40\* F weather
- Sustained precipitation
- Lightning

# School-wide Routine: Pack-Up

Ownership, Accountability and Preparedness	
<p><b>Overseen by:</b> Deans</p> <p><b>Owner(s):</b> Co-Teacher Pairs</p> <p><b>Non-Negotiables:</b></p> <ul style="list-style-type: none"><li>○ Scholars move around the room carefully and safely.</li><li>○ Teachers use calm voices to pack up scholars.</li><li>○ Teachers position themselves strategically.<ul style="list-style-type: none"><li>○ 1 teacher completes binders that were not yet completed, while managing those who are <i>not</i> playing and are at desks.</li></ul></li><li>○ Pack up is before cooperative play.</li><li>○ Cubby/Hook Pack up order lines up in the same direction as desk order.</li><li>○ If scholars are entering the classroom directly before pack up, go immediately to hooks to retrieve belongings.</li></ul>	<p><b>Materials:</b></p> <ul style="list-style-type: none"><li>○ Completed binders laid out by row</li></ul>

## Procedure:

- Teacher II is actively scanning the classroom while also completing folders and distributing to scholars.
- Teacher I calls students by row, following line up procedure, to collect backpack and coats, then return to their seats.
- After all scholars in the row return to desk, Teacher I calls next row.
- Teachers both position themselves to monitor students at desk and students who are transitioning
- Scholars participating in Cooperative Play are called by station to straighten up their space and get their jackets next.
- Scholars prepare for dismissal as follows:
  - Jacket, sweater, and accessories on the back of your chair.
  - Completed binders go inside the backpack.
  - Backpack lays flat on the desk.
  - Scholars sit in SLANT on their desk

# School-wide Routine: Social Opportunities – Pack Up/Cooperative Play

Ownership, Accountability and Preparedness	
<p><b>Overseen by: Deans and Principal</b>  <b>Owner(s): Homeroom Teachers, Interns</b></p> <p><b>Non-Negotiables:</b></p> <ul style="list-style-type: none"> <li>○ Teachers must move with Urgency to ensure scholars are able to maximize playtime.</li> <li>○ Coop Play starts at 3.45 daily.</li> <li>○ Van/Sibling scholars pack up before playing (and must be ready for dismissal by 3.48)</li> <li>○ Review rules for cooperative play every day:               <ul style="list-style-type: none"> <li>○ Restaurant voices.</li> <li>○ Kind words and actions.</li> <li>○ Safe bodies with hands to self.</li> <li>○ Stay in your center the entire time.</li> </ul> </li> <li>○ Cooperative Play is centers based. Scholars choose their center (at least 4 options per day) and sit in SLANT. Each center has a maximum of 7 scholars.</li> <li>○ During the first month of Cooperative Play scholars learn one center per week (i.e. Legos, blocks, cards, board games, whiteboard drawing, computer, etc.):</li> <li>○ Strikes 1 – 2 – 3 on the board to indicate noise level and corresponding consequence (early cleanup)</li> <li>○ Sharing objects with PETS language</li> <li>○ Keeping items on the floor and following game directions</li> <li>○ Each station spot remains the same through the year so scholars always know where to go for Coop Play.</li> <li>○ Ends at 3.55 with scholars cleaning up and returning to seats for dismissal.</li> <li>○ GLLs, during GLM, determine what games and activities to buy for their grade.</li> </ul> <p>Grades 3-4:</p> <p>Teachers must list/label out 4 permanent locations in the classroom for Coop Play: <u>3 centers and 1 place for Orange/Red scholars.</u>            Teachers may choose independent activities. Grade will norm on specific expectations            GLLs- Decide on the three games.</p> <p><b>Two Centers are always at front of the room</b>  <b>One Center is always in a back corner of the classroom</b>  <b>Orange/Red Scholars: By the window, away from the door, U-Table, at desk.</b></p>	<p><b>Materials:</b></p> <ul style="list-style-type: none"> <li>○ REACH Bar</li> <li>○ Game materials</li> </ul>



### Cooperative Play Procedure:

Teachers I & II	Scholars
<p><b>Throughout Pack Up/Coop Play:</b></p> <ul style="list-style-type: none"> <li>○ <b>Teacher I</b> completes all binders</li> <li>○ <b>Teacher I</b> ensure that all completed binders are distributed by end of Pack Up/Coop Play, 3.55, prioritizing Van/Sibling/Bus scholars, in that order.</li> <li>○ <b>Weeks 1-4</b> <ul style="list-style-type: none"> <li>○ Teacher II introduces one center/station per week. All scholars play that center for the week.</li> </ul> </li> <li>○ <b>Week 5+</b> <ul style="list-style-type: none"> <li>○ Station spots are identified by Teacher II. There should be no more than 7 scholars per station.</li> </ul> </li> </ul> <p><b>Before Coop Play/Pack Up:</b></p> <ul style="list-style-type: none"> <li>○ <b>Teacher II</b> sets out all station games just prior to Cooperative Play</li> <li>○ <b>Teacher II</b> starts Coop Play at <b>3.45</b> by calling Van/Sibling scholars to pack up and line up for dismissal per Bus/Van Dismissal CP, using Bus/Van/Dismissal list.</li> <li>○ <b>Teacher II</b> calls from Green to Gray to choose a station to play. (Due to the shortness of Coop Play, we want to ensure ALL scholars above Orange are able to play in the afternoon.)</li> <li>○ <b>Teacher II</b> stands near door at <b>3.50</b> to ensure Van/Sibling monitor is picking up scholars per Dismissal CP below.</li> <li>○ <b>At 3.52</b>, Coop Play goes to silent as bus scholars are packing up and everyone else continues to play. Meaning, at this time, teacher is quietly whispering to bus scholars to return to get their materials (back pack and jackets. Folder should be at desks already by <b>Teacher I</b>). <b>Teacher II</b> is using Bus/Van/Dismissal list to ensure appropriate dismissal of bus scholars to line up ready for dismissal per CP.</li> </ul> <p>Clean Up:</p> <ul style="list-style-type: none"> <li>○ <b>Teacher II</b> quietly circulates to each group and tells them to silently clean up and return all materials. After being dismissed in groups of no more than 7 to clean up, scholars are at seats and movie begins playing.</li> </ul>	<ul style="list-style-type: none"> <li>○ <b>Weeks 1-4</b> <ul style="list-style-type: none"> <li>○ Teacher II introduces one center/station per week. All scholars play that center for the week.</li> </ul> </li> <li>● <b>Week 5+</b> <ul style="list-style-type: none"> <li>○ Scholars choose their station, beginning with scholars on Green first. There should be no more than 7 scholars per station.</li> </ul> </li> <li>○ <b>Clean Up</b> <ul style="list-style-type: none"> <li>○ Teacher instructs each scholar group to put all game/game pieces back in a central location within their station.</li> <li>○ Individual groups of no more than 7 are dismissed to clean up and be seated.</li> </ul> </li> </ul>

- **Teacher II** stands near door at **3.55** to ensure Bus monitor is picking up scholars per Dismissal CP below.
  - **Video on by 3.55 with bus/van/sibling scholars already dismissed!**

## School-wide Routine: Bus and Van Dismissal

Ownership, Accountability and Preparedness	
<p><b>Overseen by:</b> Latia Watson</p> <p><b>Owner(s):</b> Co-Teachers and Bus Monitors</p> <p><b>Non-negotiable:</b></p> <ul style="list-style-type: none"> <li>• Scholar safety is our number one concern – dismissal needs to be smooth and clearly communicated process to ensure that all scholars remain safe as they travel from the school to their homes. We have separated the middle school and elementary school dismissals to help ensure scholars safety.</li> <li>• TWO lists MUST be used to determine who goes on the bus or van. (We cannot take a child’s word on this. It is important for the safety of our children to account for any changes in route, parent preference, or suspension.)</li> <li>• Teacher’s bus list will always be in classroom mailbox by 3.30.</li> <li>• Bus monitors list will always be on security desk by 3.30.</li> <li>• Bus monitors must pick up their list by 3.45 <b>latest</b>.</li> <li>• Teachers will use one list to call scholars by name, in sequence.</li> <li>• Bus monitors will use their list to check off scholars as they leave the classroom and silently join their line.</li> <li>• Bus monitors will then use their list to check off scholars as they board the bus.</li> <li>• Bus monitor takes any scholar of question with them and discusses it with Latia downstairs.</li> <li>• If teachers receive a text from families, they should respond with a text that says, “I am not able to make changes to the bus list. You should reach out to main office @ 718.622.5994 before 2pm to make this change.”</li> <li>• In order to maximize scholar learning during the day, our scholar dismissal period must be an efficient and effective plan to transition our scholars out of our classrooms and schools for the day.</li> <li>• All bus monitors MUST be at the starting point by 3:55pm.</li> <li>• All buses MUST exit the building by 4:04pm.</li> <li>• All van drivers with less than 10 scholars will pick up scholars as families pick up scholars.</li> <li>• Having an organized dismissal period will help set the tone of our school.</li> </ul>	<p><b>Materials:</b></p> <ul style="list-style-type: none"> <li>○ Bus and Van List</li> <li>○ End-of-day activity (Brain Pop, Reading Rainbow, or any other academically-themed media)</li> <li>○ 1 scholar helper to fully clean and store all Cooperative Play stations while Brain Pop plays.</li> <li>○ 13 Bus Monitors (8 bus, 3 van, 2 sibling)</li> </ul>

### Bus and Van Dismissal Procedure:

Teacher	Bus/Van/Sibling Monitor	Scholars
<ul style="list-style-type: none"> <li>• Retrieve bus list from classroom mailbox by 3.30.</li> <li>• While positioned at the door, at 3.48, use one list to call scholars by name, in order listed, to line.</li> <li>• Teacher calls van scholars.</li> <li>• Teacher calls bus scholars.</li> <li>• As the last group of bus riders exit at 4pm, parents enter, at 4.05.</li> </ul>	<ul style="list-style-type: none"> <li>• Bus monitors list will always be on security desk by 3.30.</li> <li>• Van monitors must pick up their list by 3.45</li> <li>• Bus monitors must pick up their list by 3.50</li> <li>• Monitors, arrive at assigned first classroom at 3.50 (van/sibling) 3.55 (bus)               <ul style="list-style-type: none"> <li>○ Begin at the back end of the hall and pick up their assigned bus/van from both sides of the hall.</li> <li>○ Bus/Van monitors nonverbally direct bus/van scholars out of the classroom and into the hallway</li> <li>○ As students exit the classroom, ensure each scholar is on your line by calling names and observing them get on the line.</li> <li>○ Move silently to the next classroom and repeat the protocol.</li> <li>○ All vans MUST exit the building by 4.00</li> <li>○ All buses MUST exit the building by 4:00pm.</li> </ul> </li> <li>• Lines move quickly and seamlessly down their respective lines to the front end of the hall without skipping any other bus lines in the hall.</li> <li>• Middle gray line remains clear for emergencies, last-minute runs, etc.</li> <li>• As the last group of bus riders exit at 4pm, parents enter, at 4.05.</li> <li>• <b>Monitors</b> use BMC and move clips in binder if necessary during transition.</li> </ul>	<ul style="list-style-type: none"> <li>• When name is called, Scholar will sit in SLANT on ground by the door.</li> <li>• Body will face the door.</li> <li>• Sounds off as you wait for dismissal.</li> <li>• When monitor arrives, scholar will silently stand and waterfall onto the back of the line.</li> <li>• As the last group of bus riders exit at 4pm, parents enter, at 4.05.</li> </ul>

Contingency Plan – Van monitors, if the van is not here, van monitor will stay with scholars while in the gym.